



# FURNACES FOR ADDITIVE MANUFACTURING



## Facts

- Production of Arts & Crafts furnaces, laboratory furnaces, dental furnaces and industrial furnaces since 1947
- Production site in Lilienthal/Bremen - Made in Germany
- 600 employees worldwide
- 150,000 customers in more than 100 countries
- Very wide product range of furnaces
- One of the biggest R&D departments in the furnace industry
- High vertical integration

## Global Sales and Service Network

- Manufacturing only in Germany
- Decentralized sales and service close to the customer
- Own sales organization and long term sales partners in all important world markets
- Individual on-site customer service and consultation
- Fast remote maintenance options for complex furnaces
- Reference customers with similar furnaces or systems close to you
- Secured spare parts supply, many spare parts available from stock
- Further information see page 86

## Setting Standards in Quality and Reliability

- Project planning and construction of tailor-made thermal process plants incl. material handling and charging systems
- Innovative controls and automation technology, adapted to customer needs
- Very reliable and durable furnace systems
- Customer test center for process assurance

## Experience in Thermal Processing

- Thermal Process Technology
- Additive Manufacturing
- Advanced Materials
- Fiber Optics/Glass
- Foundry
- Laboratory
- Dental
- Arts & Crafts

# Table of Contents



## Additive Manufacturing

Additive Manufacturing .....	6
Which furnace for which process? .....	10
Concepts for drying, debinding and sintering of parts with binder content.....	12
Safety concepts for processes which generate a combustible atmosphere.....	14

## Retort Furnaces

Hot-wall retort furnaces up to 1100 °C.....	18
Cold-wall retort furnaces up to 2400 °C.....	24
Retort furnace cooling systems .....	29

## Ovens and Forced Convection Furnaces up to 850 °C

Forced convection chamber furnaces NA 120/45 - N 500/85 and protective gas boxes .....	32
Protective gas boxes for automotive (CQI-9) and aeronautic (AMS/NADCAP) norms.....	36
Ovens, also with Safety Technology According to EN 1539.....	40
Chamber ovens .....	42

## Chamber Furnaces with Brick Insulation or Fiber Insulation

Chamber furnaces LH 15/.. - LH 216/.....	46
Protective gas boxes and charging plates for models LH 15/.. - LH 216/.....	48
Chamber furnaces with drawer bottom or as a bogie NW 150 - NW 1000 .....	50
Protective gas boxes and protective gas hoods for chamber furnaces NW 150 - NW 1000 .....	51
Chamber furnaces N 7/H - N 641/13.....	52
Protective gas boxes and charging plates for models N 7/H - N 641/13.....	55
Charging forks .....	57

## Additional Equipment Chamber and Convection Furnaces

Gas supply systems .....	60
Vacuum pump .....	61
Cooling platforms and charging devices .....	62

## Furnaces for Debinding and Sintering up to 1800 °C

Ashing Furnaces with Integrated Exhaust Gas Cleaning .....	66
High-Temperature Furnaces with MoSi2 Heating Elements up to 1800 °C.....	68

## Process Control and Documentation

Temperature uniformity and system accuracy .....	72
AMS2750F, NADCAP, CQI-9 .....	73
Nabertherm controller series 500.....	76
MyNabertherm app .....	78
Functions of the standard controllers.....	80
Process data storage and data input via PC .....	81
PLC controls .....	83
Process data storage .....	84
Nabertherm control center NCC.....	85

# Additive Manufacturing

Additive manufacturing allows for the direct conversion of design construction files into fully functional objects. With 3D-printing objects, from metals, plastics, ceramics, glass, sand or other materials are built-up in layers until they have reached their final shape.

Depending on the material, the layers are interconnected by means of a binder system or by laser technology.

Many methods of additive manufacturing require subsequent heat treatment of the manufactured components. The requirements for the furnaces for heat treatment depend on the component material, the working temperature, the atmosphere in the furnace and, of course, the additive production process.

Apart from the choice of the right model and process parameters the previous processes before the heat treatment also have an influence on the overall result. One important criteria for a good surface quality is that the components are cleaned properly before the heat treatment.

This is particularly important for the processes that are carried out under vacuum or in furnaces that have a high requirement for a low residual oxygen content. Minor leaks or contamination can lead to insufficient results. For this reason, regular cleaning and maintenance of the furnace is important.



Furnace Group	Page
Additive Manufacturing	6
Which furnace for which process?	10
Concepts for drying, debinding and sintering of parts with binder content	12
Safety concepts for processes which generate a combustible atmosphere	14

# Additive Manufacturing



Retort furnace NR 150/11 for annealing of metal parts of 3D-printing



Oven TR 240 for drying of powders



Chamber oven KTR 2000 for curing after 3D-printing



Compact tube furnace for sintering or annealing under protective gases or in a vacuum after 3D-printing



HT 160/17 DB200 for debinding and sintering of ceramics after 3D-printing

In additive manufacturing, a distinction is made between printing with and without binder. Depending on the manufacturing process, different furnace types are used for the subsequent heat treatment.

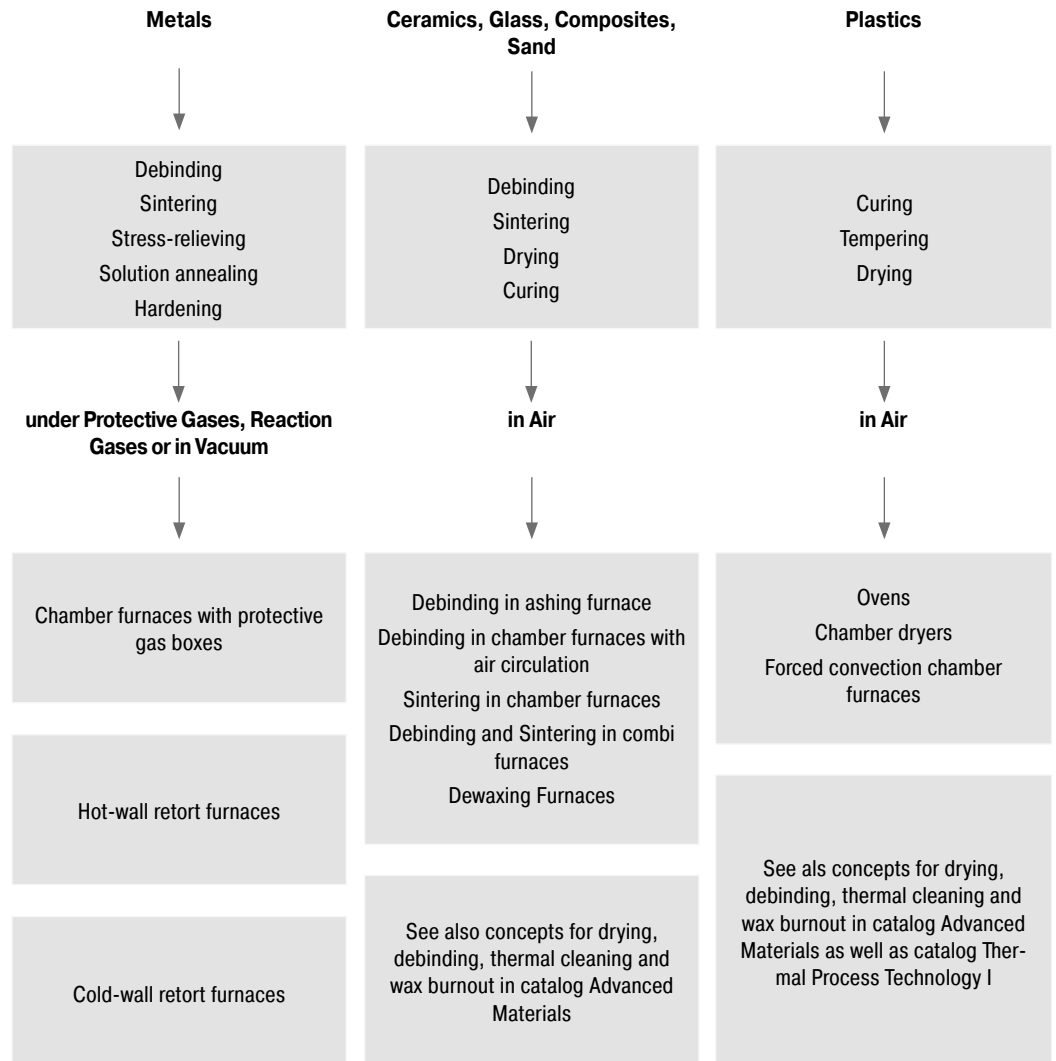

## Binder-Free Systems

In binder-free additive manufacturing, in most cases, the components are produced with the powder-based laser melting process on a printing platform. In the meantime, other manufacturing processes have also become established on the market, which likewise require a corresponding heat treatment after the production process.

The tables below show typical materials and construction platform sizes of laser-based systems that are available on the market with suggestions with respect to furnace sizes, required temperature and atmosphere in the furnace.

### Aluminum Components

Generally, aluminum is heat treated in air at temperatures between 150 °C and 450 °C.

Due to the very good temperature uniformity, forced convection chamber furnaces are suitable for processes such as tempering, aging, stress-relieving or preheating.



Printed aluminum part, heat treated in model N 250/85 HA (Manufacturer CETIM CERTEC on SUPCHAD platform)

Examples for max platform sizes	Forced convection chamber furnaces, see page 42 up to 450 °C <sup>1</sup>
210 x 210 mm	NA 30/45
280 x 280 mm	NA 60/45
360 x 360 mm	NA 120/45
480 x 480 mm	NA 250/45
600 x 600 mm	NA 500/45

<sup>1</sup>Also available for 650 °C and 850 °C



Forced convection chamber furnace NA 250/45 for heat treatment in air

### Stainless Steel and Titanium Components

In many cases, certain stainless steels and titanium are heat treated in a protective gas atmosphere at temperatures below 850 °C.

By using a protective gas box with the corresponding process gas supply, a standard furnace can be upgraded to a protective gas furnace. Depending on the type of process gas, the preflushing rate, the process flushing rate, and the condition of the box, it is possible to achieve residual oxygen concentrations of up to 100 ppm.

The forced convection chamber furnaces with protective gas boxes described below have a working temperature range between 150 °C and 850 °C. If the protective gas boxes are removed from the furnace, aluminum or steel components can also be heat treated in air.

Examples for platform sizes	Forced convection chamber furnaces, see page 42 up to 850 °C with protective gas box
100 x 100 mm	N 30/85 HA
200 x 200 mm	N 60/85 HA
280 x 280 mm	N 120/85 HA
400 x 400 mm	N 250/85 HA
550 x 550 mm	N 500/85 HA

The models listed in the table above are just a few examples.



Forced convection chamber furnace N 250/85 HA with protective gas box for heat treatment in a protective gas atmosphere



Hot-wall retort furnace NRA 150/09 for heat treatment in a protective gas atmosphere

With sensitive materials, such as titanium, the component may still oxidize due to the residual oxygen concentration in the protective gas box.

In these cases, hot-wall retort furnaces with a maximum temperature of 900 °C or 1100 °C are used. These gas tight retort furnaces are ideal for heat treatment processes that require a defined protective or reaction gas atmosphere. The compact models can also be designed for heat treatment under vacuum up to 600 °C. The risk of oxidation on the component is considerably reduced with these furnaces.

Examples for platform sizes	Hot-wall retort furnaces see page 18
200 x 200 mm	NR 20/11 and NR(A) 17/..
300 x 300 mm	NR 80/11 and NR(A) 50/..
300 x 500 mm	NR 80/11 and NR(A) 75/..
400 x 400 mm	NR 160/11 and NR(A) 150/..
400 x 800 mm	NR 160/11 and NR(A) 300/..



Titanium rods after heat treatment in NR 50/11 in argon atmosphere



Cold-wall retort furnace VHT 100/12-MO for processes in high vacuum

Cold-wall retort furnaces are used for processes in protective gas at temperatures above 1100 °C or under vacuum above 600 °C.

Examples for platform sizes	Cold-wall retort furnaces <sup>1</sup> see page 24
100 x 100 mm	VHT 8/..
250 x 250 mm	VHT 40/..
350 x 350 mm	VHT 70/..
400 x 400 mm	VHT 100/..

<sup>1</sup>Available with different heater materials and for different max. temperatures



LH 216/12 with controlled cooling, gassing system and charging device

### Inconel or Cobalt-Chromium Components

Materials such as Inconel and cobalt-chromium are generally heat treated at temperatures from 850 °C up to between 1100 °C and 1150 °C. Various furnace families are used for these processes. In many cases, the chamber furnaces of the LH .. or NW .. series with protective gas boxes are sufficient to provide an outstanding price/performance ratio. Both furnace groups are suitable for temperatures between 800 °C and 1100 °C.

Examples for platform sizes	Chamber furnaces see page 46 up to 1100 °C with protective gas box
100 x 100 mm	LH 30/12
250 x 250 mm	LH 120/12
400 x 400 mm	LH 216/12
420 x 520 mm	NW 440
400 x 800 mm	NW 660



## Systems with Binder

In 3D printing, organic binders, which evaporate during heat treatment, are used to build-up the part. The printed parts can be made of ceramic, metal, glass or sand. Depending on the evaporation volume, furnaces with graduated safety systems for debinding and sintering are used.

On pages 10 and 11 the different concepts are presented in a decision matrix and explained on the following pages.



Muffle furnace L 40/11 BO with passive safety system and integrated post combustion for thermal debinding in air



High-temperature furnace HT 64/17 DB100 with passive safety system for debinding and sintering in air



Retort furnace NRA 40/02 with cupboard for the acid pump

Printing dimensions up to (w x d x h)	Debinding furnaces <sup>1</sup> see catalog Advanced Materials	Sintering furnaces <sup>2</sup> see catalog Advanced Materials
100 x 100 x 100 mm	L 9/11 BO	LHT 4/16
200 x 200 x 150 mm	L 9/11 BO	HT 40/16
300 x 400 x 150 mm	L 40/11 BO	HT 64/17

<sup>1</sup> Values for debinding like max. organic content, or evaporation rate have to be considered

<sup>2</sup> The furnaces are available with different max. furnace chamber temperatures

### Debinding and Sintering in Protective or Reaction Gas or under Vacuum

To protect metal components that were printed using a binder-based system against oxidation, two process steps, debinding and sintering, are carried out in an oxygen-free atmosphere.

Depending on the material and the binder system, debinding is carried out either in a non-flammable protective gas (IDB), under hydrogen (H<sub>2</sub>), or catalytically in a mixture of nitric acid and nitrogen. Adapted safety systems are used to ensure the safety of these processes.

The table contains examples of furnaces which can be equipped with suitable safety technology. Hot-wall retort furnaces are used as debinding furnaces and cold-wall retort furnaces as sintering furnaces. Under certain circumstances, depending on the application, it is possible to use the same furnace for both processes.

Printing dimensions up to (w x d x h)	Hot-wall retort furnaces <sup>1</sup> see page 18	Cold-wall retort furnaces <sup>2, 3</sup> see page 24
100 x 180 x 120 mm	NRA 17/..	VHT 8/..
180 x 320 x 170 mm	NRA 17/..	VHT 25/..
230 x 400 x 220 mm	NRA 50/..	VHT 40/..
300 x 450 x 300 mm	NRA 50/..	VHT 70/..
400 x 480 x 400 mm	NRA 150/..	VHT 100/..

<sup>1</sup> Safety systems see page 16 and 19, max. oven chamber temperatures see page 14

<sup>2</sup> Available with different heater materials and for different max. temperatures

<sup>3</sup> With inner process chamber for the residual debinding

# Which Furnace for Which Process?

The next two double pages give an overview of which furnaces can be used in additive manufacturing for which process. This double page describes furnaces which can be used for processes in which no combustible substances escape.

## Atmosphere

Air

## Maximum Temperature

300 °C

850 °C

1280 °C

## Requirement Oxygen Content

21 %

21 %

21 %

## Vacuum

-

-

-

## Flammable Process Gas

-

-

-

## Furnace Type

TR, page 40  
KTR, page 42

NA, page 32

LH, page 46  
NW, page 50  
N, page 52  
KTR, page 42

## Furnace Heating

Electric



Chamber oven KTR 2000 for curing after 3D-printing



LH 216/12 with controlled cooling, gassing system and charging device



Forced convection chamber furnace NA 250/45 for heat treatment in air

## Process Gas

1100 °C	1150 °C	2400 °C
0,01 %	0,00 %	0,00 %
-	-	≤ 10 <sup>-5</sup> mbar
-	x	x
With protective gas box LH, page 46 NW, page 50 N, page 52 NA*, page 32	NR(A), page 18	VHT, page 24

## Vacuum

≤ 600 °C	≥ 600 °C
0,00 %	0,00 %
≤ 10 <sup>-5</sup> mbar	≤ 10 <sup>-5</sup> mbar
x	x
NR(A), page 18	VHT, page 24

## Electric



Cold-wall retort furnace VHT 100/12-MO for processes in high vacuum



Semi-automatic annealing plant with retort furnace NR 50/11 and water quenching bath on rails

# Concepts for Drying, Debinding and Sintering of Parts with Binder Content

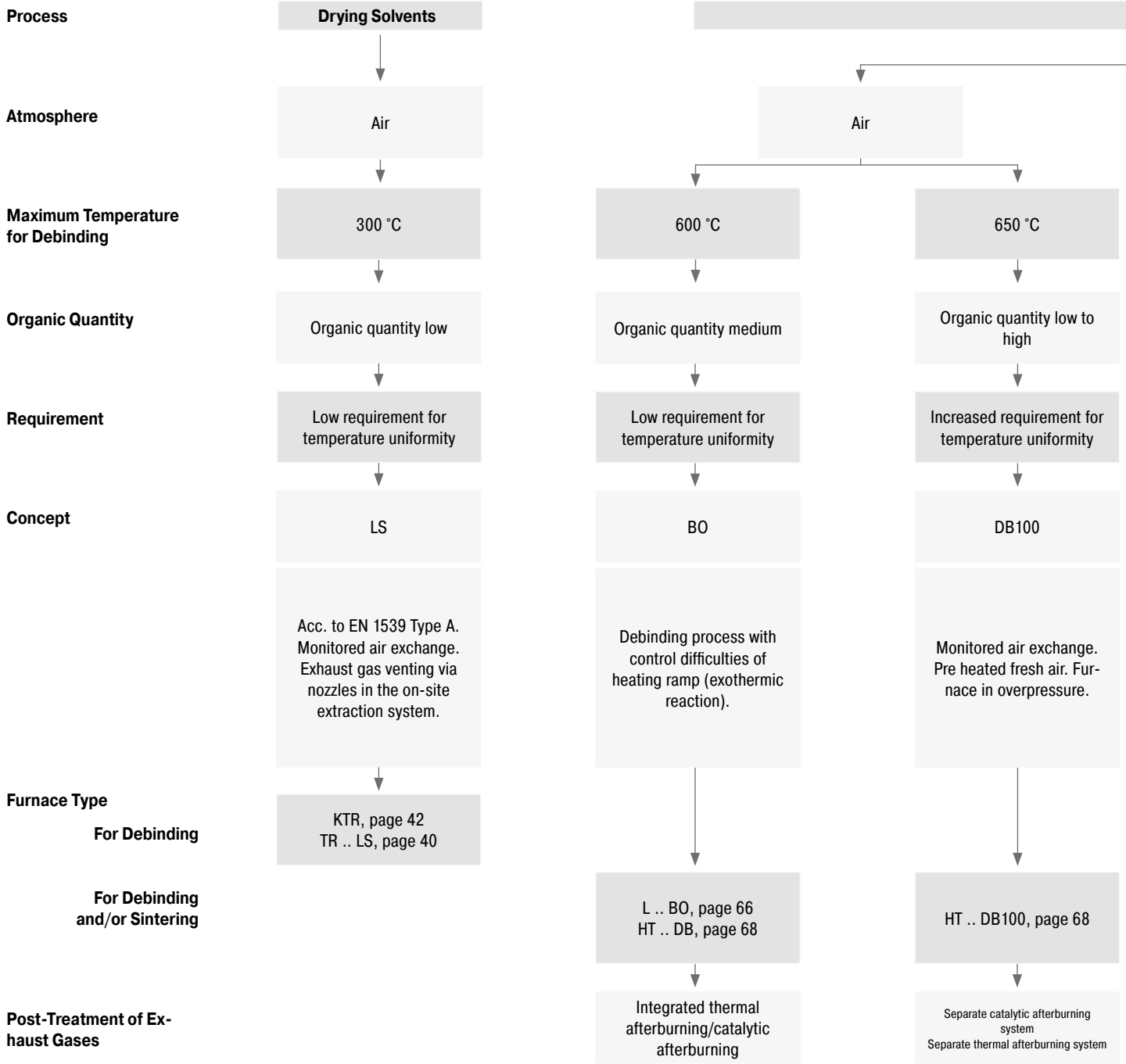

## Electric

**Furnace Heating**

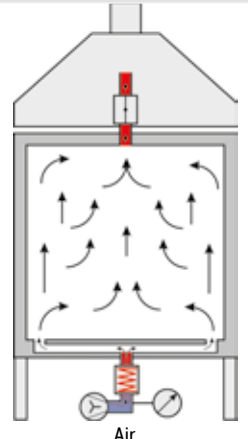
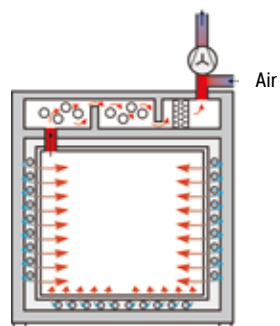
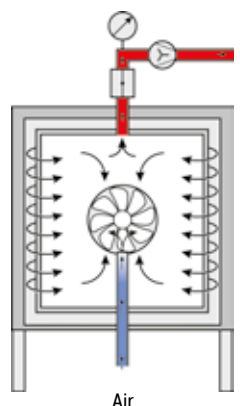

## Debinding

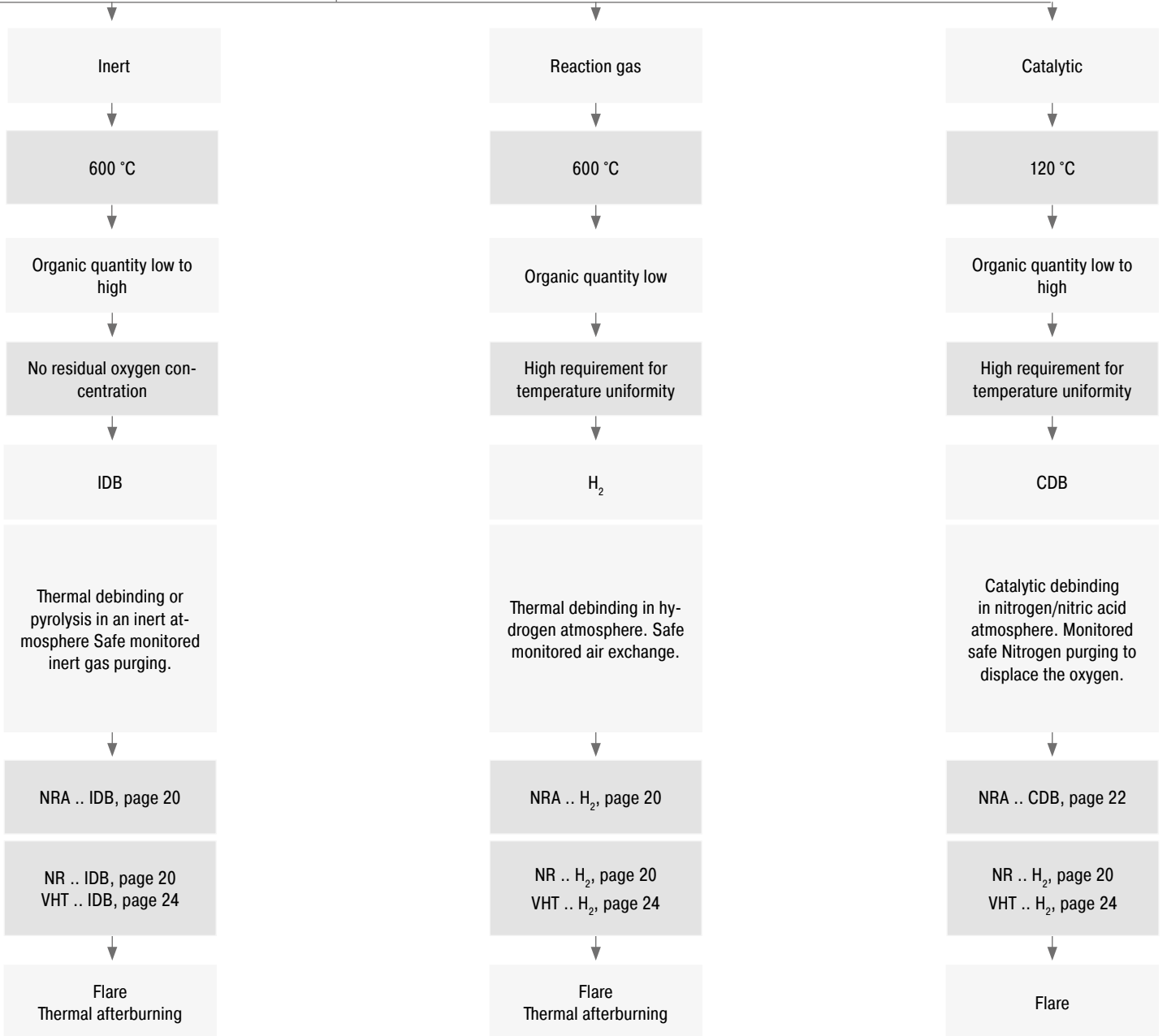

## Electric

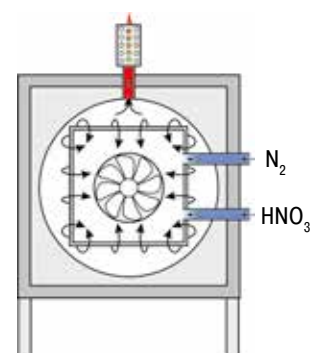
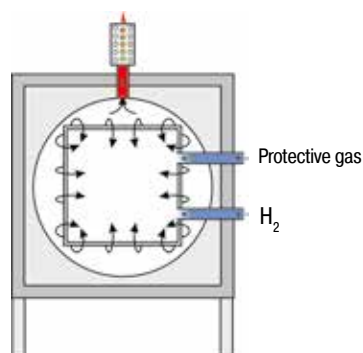
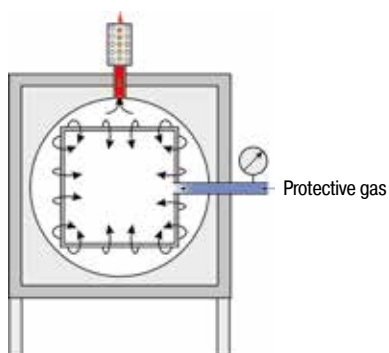

# Safety Concepts for Processes which Generate a Combustible Atmosphere

During debinding e.g. from technical ceramics, hydrocarbons are released, which might generate an ignitable mixture depending on their concentration in the furnace chamber. Nabertherm offers tailor-made passive and active safety packages depending on the process and the amount of binder, which enable safe operation of the furnace.

## I. Debinding in Air

### Debinding in an Electrically Heated Furnace

For debinding in air with electric heating Nabertherm offers various debinding packages tailored to the individual process requirements. All debinding packages have professional integrated safety technology. Passive or active safety concepts are available, depending on the specific requirements. The passive safety concepts differ upon the requirements for the quantity of organic materials, process reliability, and temperature distribution.

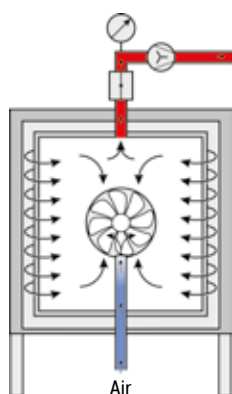

### Passive Safety Concept

Nabertherm debinding furnaces are generally equipped with a passive safety concept to allow for a slow vaporization of flammable substances. The electrically heated furnaces work according to the dilution principle by introducing fresh air to reduce the degassing from the charge to a non-ignitable atmosphere in the furnace. The customer has to define the quantity of organic materials as well as the temperature curve, to make sure that the maximum permissible rate of vaporization is not exceeded. Thus, the customer is responsible for the function of the safety concept. The furnace DB safety package monitors all safety-relevant process parameters and initiates a respective emergency program in case of a malfunction. The passive safety concept has proven itself in practice based to its good price performance ratio. Depending on the process requirements, the following equipment packages are available.

### DB10 Debinding Package for Air Circulation Furnaces (Convection Heating) up to 450 °C

The DB10 debinding package is the basic option for safe debinding in air circulation furnaces up to 450 °C. The furnace is equipped with an exhaust gas fan providing for a defined volume of air which is extracted from the furnace, thus allowing the volume of fresh air required for the debinding process to enter the furnace. The furnace is operated with negative pressure, which prevents an undefined emission of vaporization products.

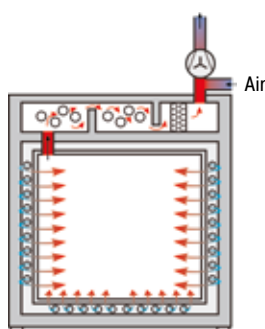

### Debinding Package for Laboratory Furnaces

The ashing furnaces have a passive safety system and integrated exhaust gas post combustion. An exhaust gas fan extracts flue gases from the furnace and simultaneously supplies fresh air to the furnace atmosphere with the result that sufficient oxygen is always available for the incineration process. The incoming air is guided behind the furnace heating and preheated to ensure good temperature uniformity. Exhaust gases are led from the furnace chamber to the integrated post combustion system, where they are postburned and catalytically cleaned. Directly after the incineration process (up to max. 600 °C) a subsequent process up to max. 1100 °C can take place.

## II. Safety Concept EN 1539 (NFPA 86) to Dry Liquid Solvents in Ovens

The safety technology of furnaces and dryers used for processes in which solvents or other flammable substances are released and vaporized relatively quickly is regulated throughout Europe in EN 1539 (or NFPA 86 in the USA)

Typical applications are drying of mold varnish, surface coatings, and impregnating resins. Users include the chemical industry as well as many other areas, such as the automotive, electric, plastic processing and metalworking industries.

The safety concept relates to preventing the formation of explosive mixtures through continuous air exchange in the entire vapor space.

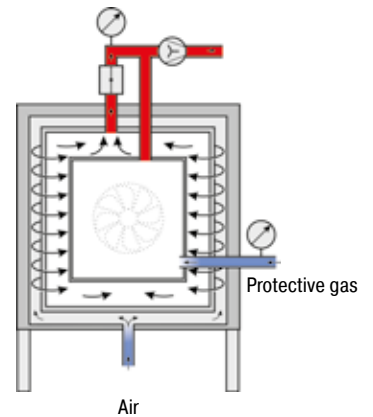

## III. Debinding or Pyrolysis under Non-Flammable or Flammable Protective or Reaction Gases

### IDB Safety Concept for Debinding in Protective Gas Boxes under Non-Flammable Protective Gases with Low Residual Oxygen

The IDB safety concept with an inert atmosphere in protective gas boxes is ideal for debinding processes under protective gas where a small amount of residual oxygen for the materials is permitted. The furnace technology in combination with a protective gas box made from heat-resistant stainless steel has a very good price performance ratio.

A monitored inert gas pre-flushing and conservation flushing during the process ensure that a residual oxygen concentration of 3 % is not exceeded in the protective gas box. The customer must check this limit value with regular measurements.

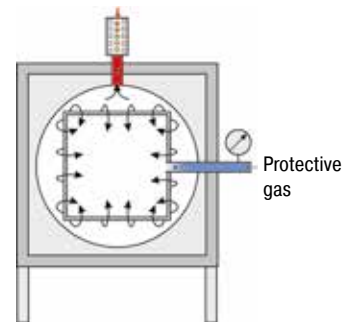

### IDB Safety Concept in Retort Furnaces for Debinding under Non-Flammable Protective Gases or for Pyrolysis Processes

The retort furnaces in the NR(A) and SR(A) series are ideal for debinding under non-flammable protective gases or for pyrolysis processes. With the IDB option, the furnace chamber is flushed with protective gases. Exhaust gases are incinerated in an exhaust gas torch. The flushing and the torch function are monitored to ensure safe operation.

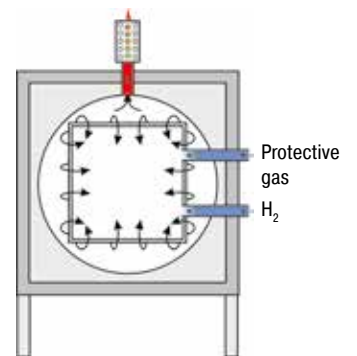

### Safety Concept for Heat Treatment under Flammable Process Gases

If flammable process gases, such as hydrogen, are used, the retort furnace is also equipped and delivered with the required safety technology. Only components with the corresponding certification are used as safety-relevant sensors. The furnace is controlled by a failsafe PLC control system (S7300/safety control).

### CDB Safety Package for Catalytic Debinding with Nitric Acid

The safety concept prevents explosive gas mixture forming when the furnace is operated with nitric acid. For this purpose, the gastight retort is automatically flushed with a controlled flow of nitrogen which displaces the atmospheric oxygen before nitric acid is introduced. During debinding, the monitored mixing ratio between the nitrogen and acid prevents an excess acid dose and, or consequently, the formation of an explosive atmosphere.

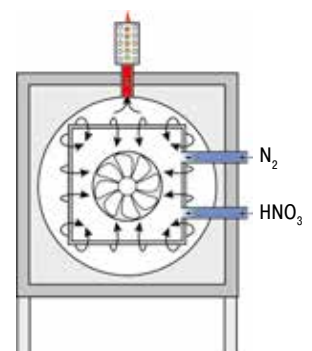

# Retort Furnaces

Retort furnaces for processes with a defined process gas atmosphere or under vacuum, for example stress relief annealing.



Exclusive use of insulation materials without categorization according to EC Regulation No 1272/2008 (CLP). This explicitly means that alumino silicate wool, also known as “refractory ceramic fiber” (RCF), which is classified and possibly carcinogenic, is not used.



NTLog Basic for Nabertherm controller: recording of process data with USB-flash drive



Defined application within the constraints of the operating instructions



As additional equipment: Process control and documentation via VCD software package for monitoring, documentation and control





Furnace Group	Model	Page
Hot-wall retort furnaces up to 1100 °C	NR(A) ..	18
Cold-wall retort furnaces up to 2400 °C	VHT ..	24
Retort furnace cooling systems		29

## Hot-Wall Retort Furnaces up to 1100 °C

These gas tight retort furnaces are equipped with direct or indirect heating depending on temperature. They are perfectly suited for various heat treatment processes requiring a defined protective or a reaction gas atmosphere with a slight overpressure. These compact models can also be laid out for heat treatment under vacuum up to 600 °C. The furnace chamber consists of a gas tight retort with water cooling around the door to protect the special sealing. With the corresponding safety technology, retort furnaces are also suitable for applications under reaction gases, such as hydrogen or, in combination with the IDB package, for inert debinding or for pyrolysis processes.

Different model versions are available depending on the temperature range:



Retort furnace NR 80/11

### Models NRA ../06 with Tmax 600 °C

- Heating elements located inside the retort
- Retort made of 1.4571 (X6CrNiMoTi 17-12-2)
- Air circulation fan  and baffle for directed gas flow
- Insulation made of mineral wool
- Furnace temperature control with measurement inside the retort

### Models NRA ../09 with Tmax 900 °C

Design like models NRA ../06 with following differences:

- Outside heating with heating elements around the retort
- Retort made of 1.4828 (X15CrNiSi 20-12)
- Multi-layer refractory insulation and micro-porous panel material
- Furnace temperature control with measurement outside the retort

### Models NR ../11 with Tmax 1100 °C

Design like models NRA ../09 with following differences:

- Retort made of 1.4841 (X15CrNiSi 25-21)
- Without gas-circulation  and baffles
- Welded support brackets

### Schematic Presentation of a Hot-Wall Retort Furnace NRA 40/09 H<sub>2</sub> with additional Equipment

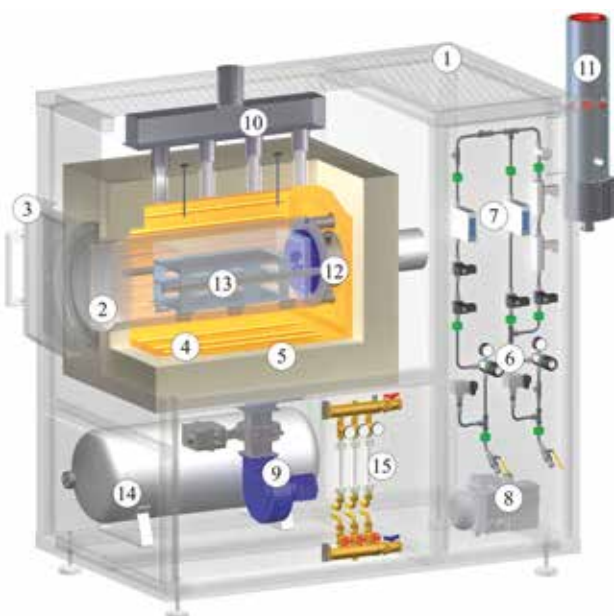

- 1 Housing with integrated switchgear
- 2 Retort
- 3 Door with bayonet catch (additional equipment)
- 4 Heating
- 5 Insulation
- 6 Gas management system
- 7 Mass flow controller MFC (additional equipment)
- 8 Vacuum pump (additional equipment)
- 9 Fan for indirect cooling (additional equipment)
- 10 Outlet indirect cooling (additional equipment)
- 11 Exhaust torch (additional equipment - H<sub>2</sub>-safety package)
- 12 Fan for gas circulation (NRA models)
- 13 Charging frame (on request)
- 14 Emergency flushing container (additional equipment - H<sub>2</sub>-safety package)
- 15 Open cooling water system



Retort furnace NRA 40/09



Retort furnace NR 20/11 with parallel swing door

## Standard Equipment

- Compact design with integrated control and gas supply (up to retort furnace NR(A) 700/..)
- Swivel door hinged on right side
- Open cooling water system
- Control divided into several heating zones
- Temperature uniformity up to  $\pm 8$  °C according to DIN 17052-1 in the empty work space see page 72
- Gas supply system for one non-flammable protective or reaction gas with flow meter and magnetic valve
- Controller P570

## Additional Equipment

- Upgrade for other non-flammable gases
- Mass flow controller MFC
- Process controls H3700, H1700 (PLC) including remote maintenance module
- Temperature control as charge control with temperature measurement inside and outside the retort
- Indirect and/or direct cooling
- Heat exchanger with closed-loop cooling water circuit for door cooling
- Oxygen sensor and dew point sensor
- Parallel swing door or electric bayonet catch
- Retort, made of 2.4633 for Tmax 1150 °C
- External switchgear with or without cabinet cooling
- Charge support or custom-built charging trolley
- Temperature uniformity optimized according to DIN 17052 or AMS2750F to  $\pm 5$  °C in empty work space see page 72

	NRA ../06	NRA ../09	NR ../11
Tmax in °C	600	900	1100 <sup>1</sup>
Atmosphere circulation	✓	✓	–
Operation with non-flammable protective gas	✓	✓	✓
Operation with air/oxygen <sup>2</sup>	✓	✓	✓
Operation with flammable gas <sup>3</sup>	✓ <sup>5</sup>	✓	✓
Inert debinding IDB <sup>3</sup>	✓	✓	✓
Low vacuum $\leq 10$ mbar <sup>4</sup>	✓	✓	✓
Fine vacuum $> 10^{-3}$ mbar <sup>4</sup>	✓	✓	✓
High vacuum $< 10^{-4}$ mbar <sup>4</sup>	✓ <sup>5</sup>	✓	✓
Retort Heating	outside/inside <sup>6</sup>	outside	outside

<sup>1</sup>Up to 1150 °C with 2.4633 as retort material without a circulation fan

<sup>2</sup>Increased wear on the retort and the attachments

<sup>3</sup>Only in connection with the corresponding safety package

<sup>4</sup>Up to 600 °C vacuum operation; 650 °C with 2.4633 as retort material without a circulation fan

<sup>5</sup>Only if heated from the outside

<sup>6</sup>Only available from size NRA 300/06 on

Model	Outer dimensions <sup>1</sup> in mm			Work space dimensions in mm			Useful volume in l	Connected <sup>1</sup> load in kW*
	W	D	H	w	d	h		
NR(A) 20/..	1100 <sup>2</sup>	1600	1700	225	400	225	20	34
NR(A) 40/..	1200 <sup>2</sup>	1600	1900	325	400	325	40	34
NR(A) 80/..	1200 <sup>2</sup>	2000	1900	325	750	325	80	44
NR(A) 100/..	1400 <sup>2</sup>	1800	2100	450	500	450	100	64
NR(A) 160/..	1400 <sup>2</sup>	2100	2100	450	800	450	160	74
NR(A) 300/..	2200	3100	2600	590	900	590	300	157
NR(A) 400/..	2200	3400	2600	590	1200	590	400	187
NR(A) 500/..	2300 <sup>3</sup>	3300	2700	720	1000	720	500	217
NR(A) 700/..	2300 <sup>3</sup>	3500	2700	720	1350	720	700	287
NR(A) 1000/..	2300 <sup>3</sup>	3600	2800	870	1350	870	1000	307

<sup>1</sup>Outer dimensions and connected load of models NR ../11

<sup>2</sup>Outer dimensions plus separate switchgear with gas supply package for flammable gases or PLC control

\*Please see page 80 for more information about supply voltage

<sup>3</sup>Outer dimensions plus separate switchgear



Retort furnace NRA 300/09 H<sub>2</sub> for heat treatment under hydrogen

## H<sub>2</sub> Version for Operation with Flammable Process Gases

When using flammable process gases, such as hydrogen from ambient temperature, these furnaces are equipped with a safety package. Only certified components are used as safety-relevant sensors.

### Standard Equipment

- Safety concept for using flammable gases
- Supply of flammable process gas at controlled overpressure of 50 mbar relative
- Process control H3700 with PLC for data input
- All safety-relevant values monitored by a failsafe PLC system
- Redundant magnetic valves for hydrogen
- Monitored pre-pressures of all process gases
- Bypass for safe flushing of furnace chamber with inert gas
- Torch for thermal post combustion of exhaust gases
- Emergency flood container for purging the furnace in case of failure



Retort furnace NRA 400/03 IDB with thermal post combustion system

## IDB Version for Debinding under Non-Flammable Protective Gases

For debinding under non-flammable protective gases or for pyrolysis processes.

### Standard Equipment

- Safety concept for inert debinding and pyrolysis processes
- Process control under monitored overpressure
- Process control H1700 with PLC controls and graphic touch panel for data input
- All safety-relevant values monitored by a failsafe PLC system
- Monitored gas pre-pressure of the process gas
- Bypass for safe flushing of furnace chamber with inert gas
- Thermal post combustion of exhaust gases



Retort furnace NR 300/08 for treatment in high vacuum

## Vacuum Version for Operation in High Vacuum

The furnaces can be equipped with the corresponding high vacuum technology for processes that take place in high vacuum to 600 °C.

### Standard Equipment

- Process control H1700 with PLC controls
- Turbomolecular pump with booster pump for an ultimate vacuum of < 10<sup>-5</sup> mbar in the cold furnace
- Process gas connection with protective gas or compressed air to fill the furnace at the end of the process



Hot-wall retort furnaces NR 1000/11 in production



Hot-wall retort furnace NRA 3300/06 with automatic door opening for the integration in a fully automatic quench & temper plant

## Solutions for Customer-Specific Applications

With their high level of flexibility and innovation, Nabertherm offers the optimal solution for customer-specific applications.

Based on our standard models, we develop individual solutions also for integration in overriding process systems. The solutions shown on this page are just a few examples of what is feasible. From working under vacuum or protective gas via innovative control and automation technology for a wide selection of temperatures, sizes, lengths and other properties of retort furnaces – we will find the appropriate solution for a suitable process optimization.



Semi-automatic annealing plant with retort furnace NR 50/11 and water quenching bath on rails



Hot-wall retort furnace NRA 1700/06 with charging frame. For grey room/clean room installation for heat treatment of glass under protective gases.



Electric bayonet catch



Charging support and TUS measuring frame for retort furnace NR 20/11



Gas supply system with mass flow controller

# Retort Furnaces for Catalytic Debinding also as Combi Furnaces for Catalytic or Thermal Debinding

The retort furnaces NRA 40/02 CDB and NRA 150/02 CDB are specially developed for catalytic debinding of ceramics and metallic powder injection molded parts. They are equipped with a gastight retort with inside heating and gas circulation. During catalytic debinding, the polyacetal-containing (POM) binder chemically decomposes in the oven under nitric acid and is carried out of the oven by a nitrogen carrier gas and burned in an exhaust gas torch. Both retort furnaces have a comprehensive safety package to protect the operator and the surrounding.

Executed as combi furnace series CTDB these retort furnace can be used for either catalytic or thermal debinding incl. presintering if necessary and possible. The presintered parts can be easily transferred into the sintering furnace. The sintering furnace remains clean as no residual binder can exhaust anymore.



Retort furnace NRA 40/02 with cupboard for the acid pump



Acid pump for nitric acid



Retort with internal heating

## Standard Equipment

- Retort made of acid-resistant stainless steel 1.4571 with large swiveling door
- Four-side heating inside the retort through chromium steel tube heating elements for good temperature uniformity
- Horizontal gas circulation for uniform distribution of the process atmosphere
- Acid pump and acid vessel (to be provided by the customer) accommodated in the furnace frame
- Gas-fired exhaust gas torch with flame monitoring
- Extensive safety package with redundantly operating safety PLC for safe operation with nitric acid
- Large, graphic process control H3700 for entering data and for process visualization
- Emergency tank for flushing in case of a failure
- Defined application within the constraints of the operating instructions

## Version NRA .. CDB

- Tmax 200 °C
- Automatic gas supply system for nitrogen with mass flow controller
- Adjustable acid volume and correspondingly adjusted gas supply volumes

## Version NRA .. CTDB

- Available for 600 °C and 900 °C with atmosphere circulation

## Additional equipment

- Scale for the nitric acid vessel, connected to the PLC monitors the acid consumption and visualizes the fill level of the acid vessel (NRA 150/02 CDB)
- Lift truck for easy loading of the furnace
- Cupboard for acid pump
- Process control and documentation via Nabertherm Control Center (NCC) for monitoring, documentation and control see page 76

Model	Tmax °C	Inner dimensions in mm			Volume in l	Outer dimensions <sup>3</sup> in mm			Heating power in kW <sup>2</sup>	Electrical connection*	Weight in kg	Acidic quantity (HNO <sub>3</sub> )	Nitrogen (N <sub>2</sub> )
		w	d	h		W	D	H					
NRA 40/02 CDB	200	300	450	300	40	1400	1600	2400	2	3-phase <sup>1</sup>	800	max. 70 ml/h	1000 l/h
NRA 150/02 CDB	200	450	700	450	150	1650	1960	2850	20	3-phase <sup>1</sup>	1650	max. 180 ml/h	max. 4000 l/h

<sup>1</sup>Heating only between two phases

<sup>2</sup>Depending on furnace design connected load might be higher

\*Please see page 80 for more information about supply voltage

<sup>3</sup>External dimensions vary when furnace is equipped with additional equipment. Dimensions on request.



# Cold-Wall Retort Furnaces up to 2400 °C

The compact retort furnaces of the VHT product line are available as electrically heated chamber furnaces with graphite, molybdenum, tungsten or MoSi<sub>2</sub> heating. A wide variety of heating designs as well as a complete range of accessories provide for optimal retort furnace configurations even for sophisticated applications.

The vacuum-tight retort allows heat treatment processes either in protective and reaction gas atmospheres or in a vacuum, subject to the individual furnace specs to 10<sup>-5</sup> mbar. The basic furnace is suited for operation with non-flammable protective or reactive gases or under vacuum. The H<sub>2</sub> version provides for operation under hydrogen or other flammable gases. Key of the specification up is a certified safety package providing for a safe operation at all times and triggers an appropriate emergency program in case of failure.



Molybdenumdisilicide heater and fiber insulation



Molybdenum or tungsten heating chamber



Graphite heating chamber

## Alternative Heating Specifications

In general the following variants are available with respect to the process requirements:

### VHT ../.-GR with Graphite Insulation and Heating

- Suitable for processes under protective and reaction gases or under vacuum
- Tmax 1800 °C, 2200 °C or 2400 °C (VHT 40/.. - VHT 100/..)
- Max. vacuum up to 10<sup>-4</sup> mbar depending on pump type used
- Graphite felt insulation

### VHT ../.-MO or VHT ../.-W with Molybdenum or Tungsten Heating

- Suitable for high-purity processes under protective and reaction gases or under high vacuum
- Tmax 1200 °C, 1600 °C or 1800 °C (see table)
- Max. vacuum up to 10<sup>-5</sup> mbar depending on pump type used
- Insulation made of molybdenum resp. tungsten radiation sheets

### VHT ../.-KE with Fiber Insulation and Heating through Molybdenum Disilicide Heating Elements

- Suitable for processes under protective and reaction gases, in air or under vacuum
- Tmax 1800 °C
- Max. vacuum up to 10<sup>-2</sup> mbar (up to 1300 °C) depending on pump type
- Insulation made of high purity aluminum oxide fiber
- Exclusive use of insulation materials without categorization according to EC Regulation No 1272/2008 (CLP). This explicitly means that aluminosilicate wool, also known as "refractory ceramic fiber" (RCF), which is classified and possibly carcinogenic, is not used.

	VHT ../.-GR	VHT ../.-MO	VHT ../-18-W	VHT ../-18-KE
Tmax	1800 °C, 2200 °C or 2400 °C	1200 °C or 1600 °C	1800 °C	1800 °C
Inert gas	✓	✓	✓	✓
Air/Oxygen	-	-	-	✓
Hydrogen	✓ <sup>3,4</sup>	✓ <sup>3</sup>	✓ <sup>3</sup>	✓ <sup>1,3</sup>
Rough vacuum and fine vacuum (>10 <sup>-3</sup> mbar)	✓	✓	✓	✓ <sup>2</sup>
High vacuum (<10 <sup>-3</sup> mbar)	✓ <sup>4</sup>	✓	✓	✓ <sup>2</sup>
Material of heater	Graphite	Molybdenum	Tungsten	MoSi <sub>2</sub>
Material of insulation	Graphite felt	Molybdenum	Tungsten/Molybdenum	Ceramic fiber

<sup>1</sup>Tmax reduces to 1400 °C

<sup>2</sup>Depending on the temperature

<sup>3</sup>Only with safety package for flammable gases

<sup>4</sup>Up to 1800 °C



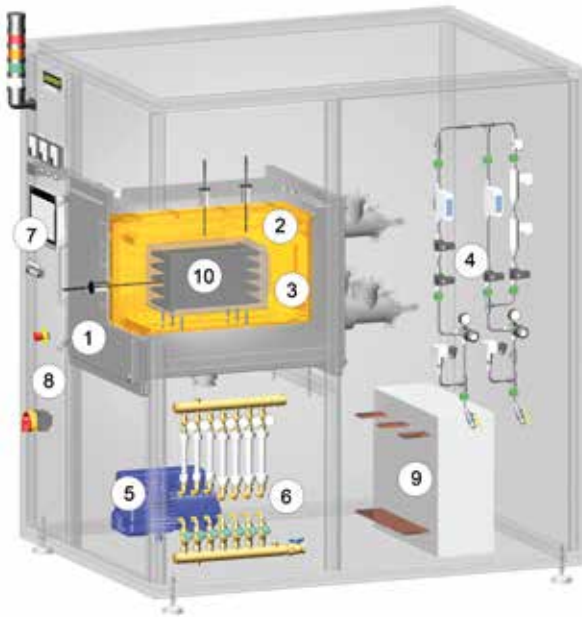

Schematic presentation of a cold-wall retort furnace with additional equipment

- 1 Retort
- 2 Heating
- 3 Insulation
- 4 Gas management system
- 5 Vacuum pump
- 6 Cooling water distribution
- 7 Controls
- 8 Integrated switchgear
- 9 Heating transformer
- 10 Charging frame inside the inner process chamber



Retort furnace VHT 100/16-MO with automation package

## Standard Equipment

- Standard furnace sizes 8 - 500 liters
- Water-cooled retort made of stainless steel
- Frame made of stable steel profiles, easy to service due to easily removable stainless steel panels
- Housing of the VHT 8 model on castors for easy repositioning of furnace
- Cooling water manifold with manual tap, automatic flow monitoring, open-loop cooling water system
- Adjustable cooling water circuits with flowmeter and temperature indicator and overtemperature protection
- Switchgear and controller integrated in furnace housing
- Process control with controller P570
- Over-temperature limiter with adjustable cutout temperature as temperature limiter to protect the oven and load
- Manual operation of the process gas and vacuum functions
- Manual gas supply for one process gas (N<sub>2</sub>, Ar or non-flammable forming gas) with adjustable flow
- Bypass with manual valve for rapid filling or flooding of furnace chamber
- Manual gas outlet with overflow valve (20 mbar relative) for over-pressure operation
- Single-stage rotary vane pump with ball valve for pre-evacuating and heat treatment in a rough vacuum to 5 mbar
- Pressure gauge for visual pressure monitoring
- Defined application within the constraints of the operating instructions



Retort furnace VHT 8/16-MO with automation package



Heat treatment of copper bars under hydrogen in retort furnace VHT 8/16-MO



Thermocouple, type S with automatic pull-out device for precise control results in the low temperature range



Turbo-molecular pump

### Additional Equipment Gas Management System

- Manual gas supply for second process gas ( $N_2$ , Ar or non-flammable forming gas) with adjustable flow and bypass
- Mass flow controller for alternating volume flow and generation of gas mixtures with second process gas (only with automation package)
- Inner process box made of molybdenum, tungsten, graphite or CFC, especially recommended for debinding processes. The box is installed in the furnace with direct gas inlet and outlet and provides for better temperature uniformity. Generated exhaust gases will be directly lead out the inner process chamber during debinding. The change of gas inlet paths after debinding results in a clean process gas atmosphere during sintering.

### Additional Equipment Vacuum

- Two-stage rotary vane pump with ball valve for pre-evacuating and heat-treating in a fine vacuum (up to  $10^{-2}$  mbar) incl. electronic pressure sensor
- Turbo molecular pump with slide valve for pre-evacuation and for heat treatment in a high vacuum (up to  $10^{-5}$  mbar) including electronic pressure sensor and booster pump
- Other vacuum pumps on request
- Partial pressure operation: protective gas flushing at controlled underpressure (only with automation package)

### Additional Equipment Cooling

- Heat exchanger with closed-loop cooling water circuit
- Direct cooling see page 29

### Additional Equipment for Controls and Documentation

- Charge thermocouple with display
- Temperature measurement at 2200 °C models with pyrometer in the upper temperature range and thermocouple, type C with automatic pull-out device for precise control results in the low temperature range (VHT 40/..-GR and larger)
- Automation package with process control H3700
  - 12" graphic touch panel
  - Input of all process data like temperatures, heating rates, gas injection, vacuum at the touch panel
  - Display of all process-relevant data on a process control diagram
  - Automatic gas supply for one process gas ( $N_2$ , argon or non-flammable forming gas) with adjustable flow
  - Bypass for flooding and filling the chamber with process gas controlled by the program
  - Automatic pre- and post programs, including leak test for safe furnace operation
  - Automatic gas outlet with bellows valve and overflow valve (20 mbar relative) for over-pressure operation
  - Transducer for absolute and relative pressure
- Process control and documentation via VCD software package or Nabertherm Control Center (NCC) for monitoring, documentation and control see page 76



Graphite inner process chamber incl. charge holder

## Process Box for Debinding in Inert Gas

Certain processes require charges to be debinded in non-flammable protective or reactive gases. For these processes we fundamentally recommend a hot-wall retort furnace (see models NR .. or SR ..). These retort furnaces can ensure that the formation of condensation will be avoided as thoroughly as possible.

If there is no way to avoid the escape of small amounts of residual binder during the process, even in the VHT furnace, the retort furnace should be designed to meet this contingency.

The furnace chamber is equipped with an additional process box that has a direct outlet to the exhaust gas torch through which the exhaust gas can be directly vented. This system enables a substantial reduction in the amount of furnace chamber contamination caused by the exhaust gases generated during debinding.

Depending on the exhaust gas composition the exhaust gas line can be designed to include various options.

- Exhaust gas torch for burning off the exhaust gas
- Condensation trap for separating out binding agents
- Exhaust gas post-treatment, depending on the process, via exhaust gas washers
- Heated exhaust gas outlet to avoid condensation deposits in the exhaust gas line



Molybdenum inner process chamber incl. six charge supports

Model	Inner dimensions of process box in mm			Volume in l
	w	d	h	
VHT 8/..	120	210	150	3.5
VHT 25/..	200	350	200	14.0
VHT 40/..	250	430	250	25.0
VHT 70/..	325	475	325	50.0
VHT 100/..	425	500	425	90.0
VHT 250/..	575	700	575	230.0
VHT 500/..	725	850	725	445.0

Model	Inner dimensions in mm			Volume in l	Max. charge weight/kg	Outer dimensions <sup>6</sup> in mm			Heating power in kW <sup>4</sup>			
	w	d	h			W	D	H	Graphite	Molybdenum	Tungsten	Ceramic fiber
VHT 8/..	170	240	200	8	5	1250 (800) <sup>1</sup>	1100	2700 <sup>5</sup>	27/27/- <sup>2</sup>	19/34 <sup>3</sup>	50	12
VHT 25/..	250	400	250	25	20	1500	2500	2200	70/90/- <sup>2</sup>	45/65 <sup>3</sup>	85	25
VHT 40/..	300	450	300	40	30	1600	2600 <sup>5</sup>	2300	83/103/125 <sup>2</sup>	54/90 <sup>3</sup>	110	30
VHT 70/..	375	500	375	70	50	1800 <sup>5</sup>	3300 <sup>5</sup>	2400	105/125/150 <sup>2</sup>	70/110 <sup>3</sup>	130	55
VHT 100/..	450	550	450	100	75	1900	3500 <sup>5</sup>	2500	131/155/175 <sup>2</sup>	90/140 <sup>3</sup>	on request	85
VHT 250/..	600	750	600	250	175	3000 <sup>1</sup>	4300	3100	180/210/- <sup>2</sup>	on request	on request	on request
VHT 500/..	750	900	750	500	350	3200 <sup>1</sup>	4500	3300	220/260/- <sup>2</sup>	on request	on request	on request

<sup>1</sup>With separated switching system unit

<sup>2</sup>1800 °C/2200 °C

<sup>3</sup>1200 °C/1600 °C

<sup>4</sup>Depending on furnace design connected load might be higher

<sup>5</sup>Dimensions may be smaller depending on the heater type

<sup>6</sup>External dimensions vary when furnace is equipped with additional equipment. Dimensions on request.



Single-stage rotary vane pump for heat treatment in a rough vacuum to 5 mbar



Two-stage rotary vane pump for heat treatment in a vacuum to 10<sup>-2</sup> mbar



Turbo-molecular pump with booster pump for heat treatment in a vacuum to 10<sup>-5</sup> mbar



Retort furnace VHT 40/16-MO H<sub>2</sub> with hydrogen extension package and process box



Retort furnace VHT 100/15-KE H<sub>2</sub> with fiber insulation and extension package for operation under hydrogen, 1400 °C

### H<sub>2</sub> Version for Operation with Hydrogen or other Reaction Gases

In the H<sub>2</sub> version the retort furnaces can be operated under hydrogen or other reaction gases. For these applications, the systems are additionally equipped with the required safety technology. Only certified and industry proven safety sensors are used. The retort furnaces are controlled by a fail-safe PLC control system (S7-300F/safety controller).

#### Standard Equipment

- Certified safety concept
- Automation package (additional equipment see page 26)
- Redundant gas inlet valves for hydrogen
- Monitored pre-pressures of all process gases
- Bypass for safe purging of furnace chamber with inert gas
- Pressure-monitored emergency flooding with automated solenoid valve opening
- Electric or gas-heated exhaust gas torch for H<sub>2</sub> post-combustion
- Atmospheric operation: H<sub>2</sub>-purging of retort starting from room temperature at controlled over pressure (50 mbar relative)

#### Additional Equipment

- Partial pressure operation: H<sub>2</sub> flushing at underpressure in the retort starting from 750 °C furnace chamber temperature
- Inner process hood in the retort for debinding under hydrogen
- Process control and documentation via Nabertherm Control Center (NCC) for monitoring, documentation and control see page 76



Gas management system

## Retort Furnace Cooling Systems

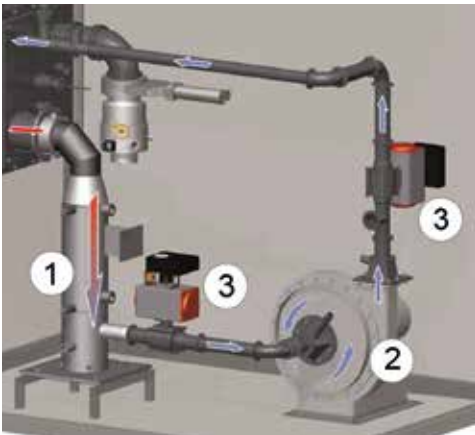

Schematic presentation of rapid gas cooling

- 1 Gas heat exchanger
- 2 Radial fan
- 3 Shut-off valves



Fan cooling, hot-wall retort furnace NRA 400/03



Rapid gas cooling, cold-wall retort furnace VHT 8/16-MO

### Indirect cooling (hot-wall retort furnaces)

- Ambient air is blown onto the outer retorte surface to cool it down. The waste heat is removed via the exhaust air outlet of the furnace.
- The charge is cooled indirectly, which means that the atmosphere in the retort is not affected by the cooling
- The charge cannot be quenched with the cooling system

### Direct cooling (cold-wall and hot-wall retort furnaces)

- Rapid gas cooling in the retort. For this purpose, the furnace atmosphere is circulated through a heat exchanger.
- The system pressure is not increased by the cooling; there is no gas quenching at high pressure
- Not available for processes with flammable furnace atmospheres

### Cooling Behavior of Hot-Wall Retort Furnace with Charge

(Example: NRA 50/09 with charge of 40 kg)

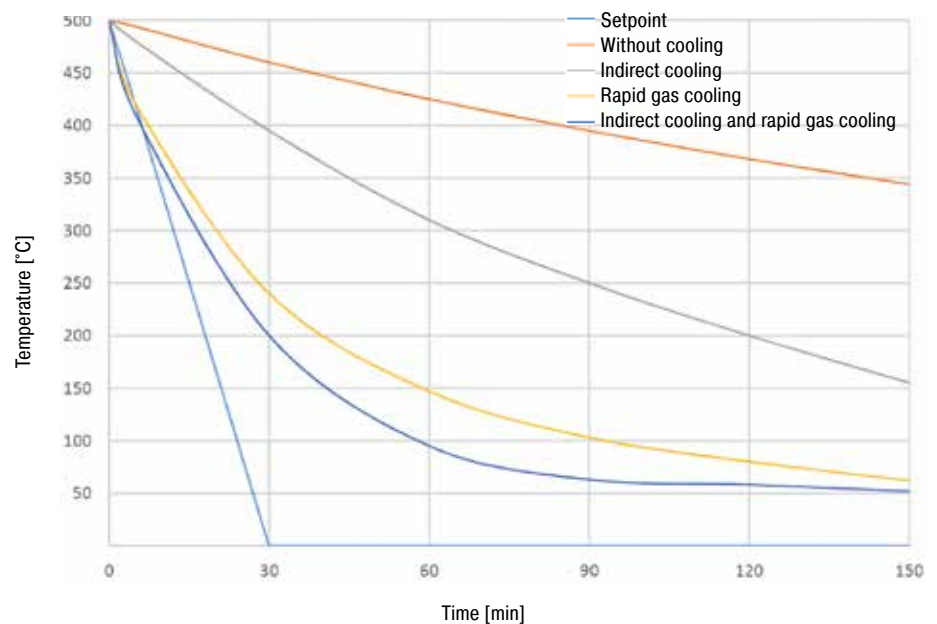

### Cooling Behavior of Cold-Wall Retort Furnace with Charge

(Example: VHT 8/06-MO with charge of 10 kg)

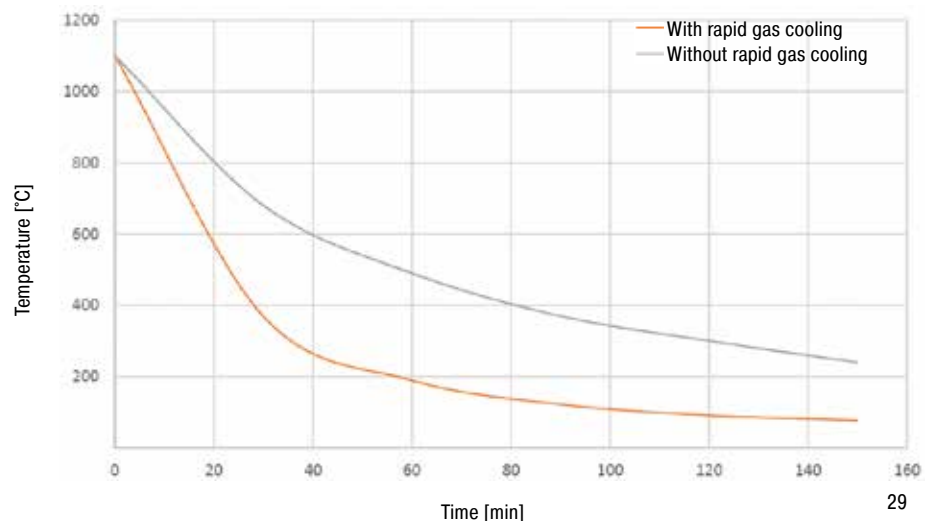

# Ovens and Forced Convection Furnaces up to 850 °C

Furnaces with forced air circulation, resulting in a very good temperature uniformity



Dual shell housing made of textured stainless steel sheets with additional fan cooling for low surface temperature



Solid state relays provide for lownoise operation



Exclusive use of insulation materials without categorization according to EC Regulation No 1272/2008 (CLP). This explicitly means that aluminosilicate wool, also known as “refractory ceramic fiber” (RCF), which is classified and possibly carcinogenic, is not used.



NTLog Basic for Nabertherm controller: recording of process data with USB-flash drive



Defined application within the constraints of the operating instructions



As additional equipment: Process control and documentation via VCD software package for monitoring, documentation and control

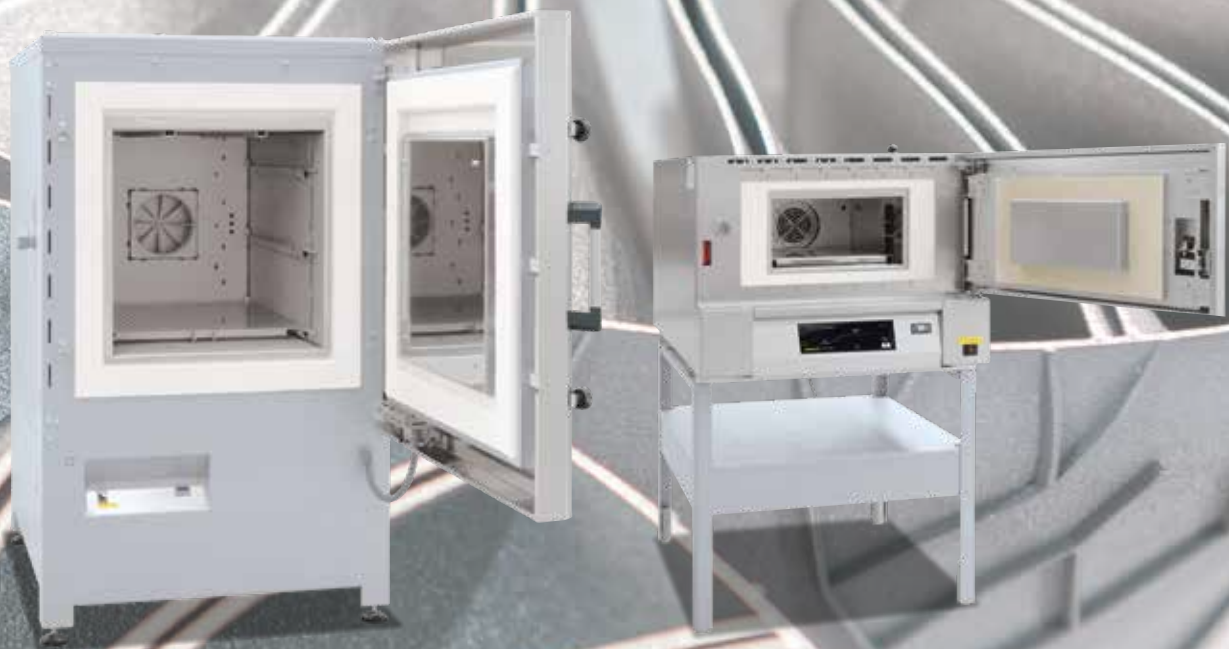

Furnace Group	Model	Page
Forced convection chamber furnaces and protective gas boxes	NA 120/45 - NA 675/85	32
Protective gas boxes for automotive (CQI-9) and aeronautic (AMS/NADCAP) norms		36
Ovens	TR 30 - 1050	40
Chamber ovens	KTR 1000 - KTR 22500	42

## Forced Convection Chamber Furnaces up to 675 Liter electrically heated

The very good temperature uniformity of these chamber furnace with air circulation provides for ideal process conditions for annealing, curing, solution annealing, artificial ageing, sintering of PTFE, preheating, or soft annealing and brazing. The forced convection chamber furnaces are equipped with a suitable annealing box for soft annealing of copper or tempering of titanium, and also for annealing of steel under non-flammable protective or reaction gases. The modular forced convection chamber furnace design allows for adaptation to specific process requirements with appropriate accessories.



Forced convection chamber furnace NA 500/65

### Standard Equipment

- Tmax 450 °C, 650 °C, or 850 °C
- Horizontal air circulation with optimum distribution through stainless steel baffles
- Swing door hinged on the right side
- Base frame included in the delivery
- Temperature uniformity up to  $\pm 4$  °C according to DIN 17052-1 see page 72
- Optimum air distribution enabled by high flow speeds
- One frame sheet and rails for two additional trays included in the scope of delivery
- Controller with touch operation B500 (5 programs with 4 segments each), controls description see page 76

### Additional Equipment for Models up to 450 °C

- Air inlet and exhaust air flaps when used for drying
- Controlled cooling via controlled flap and fan
- Additional frame sheet
- Gas supply boxes for different charging methods
- Gas feed fittings
- Charge control with documentation of the charge thermocouple
- Signal tower
- Charging systems



Forced convection chamber furnace NA 250/85

### Further Additional Equipment for Models up to 850 °C

- Optimization of the temperature uniformity up to  $\pm 3$  °C according to DIN 17052-1 see page 72
- Measuring frames and thermocouples for TUS measurements charge or comparative measurements
- Version according to AMS2750F or CQI-9
- Manual lift door (up to model NA 120/..)
- Pneumatic lift door
- Manual roller conveyor in furnace chamber for high charge weights





Forced convection chamber furnace NA 250/45



Forced convection chamber furnace NA 120/45 with fresh-air cooling as additional equipment

Model	Tmax °C	Inner dimensions in mm			Volume in l	Outer dimensions <sup>1</sup> in mm			Heating power in kW <sup>2</sup>	Electrical connection <sup>*</sup>	Weight in kg	Heat-up time <sup>3</sup> to Tmax in minutes	Cool-down time <sup>3</sup> from Tmax to 150 °C in minutes	
		w	d	h		W	D	H					Flaps <sup>4</sup>	Fan cooling <sup>4</sup>
NA 120/45	450	450	600	450	120	1250	1550	1550	9.0	3-phase	460	60	240	30
NA 250/45	450	600	750	600	250	1350	1650	1725	12.0	3-phase	590	60	120	30
NA 500/45	450	750	1000	750	500	1550	1900	1820	18.0	3-phase	750	60	240	30
NA 60/65	650	350	500	350	60	910	1390	1475	9.0	3-phase	350	120	270	60
NA 120/65	650	450	600	450	120	990	1470	1550	12.0	3-phase	460	60	300	60
NA 250/65	650	600	750	600	250	1170	1650	1680	20.0	3-phase	590	90	270	60
NA 500/65	650	750	1000	750	500	1290	1890	1825	27.0	3-phase	750	60	240	60
NA 60/85	850	350	500	350	60	790	1330	1440	9.0	3-phase	315	150	900	120
NA 120/85	850	450	600	450	120	890	1420	1540	12.0	3-phase	390	150	900	120
NA 250/85	850	600	750	600	250	1120	1690	1810	20.0	3-phase	840	180	900	180
NA 500/85	850	750	1000	750	500	1270	1940	1960	30.0	3-phase	1150	180	900	210
NA 675/85	850	750	1200	750	675	1270	2190	1960	30.0	3-phase	1350	210	900	210

<sup>1</sup>External dimensions vary when furnace is equipped with additional equipment. Dimensions on request.

<sup>2</sup>Depending on furnace design connected load might be higher

<sup>3</sup>Approx. information in empty furnace

<sup>4</sup>Additional equipment

\*Please see page 80 for more information about supply voltage



Port for thermocouple



Tray



Roller conveyor in furnace chamber

## Protective Gas Boxes for Models NA 120/45 - NA 675/85

For the heat treatment, workpieces are placed in the box, the lid is locked using the sealing locks and flushed with protective gas outside the furnace for some time and then placed in the furnace. Depending on the weight, a charging cart (page 30) is recommended.



Forced convection chamber furnace NA 250/85 with protective gas box

### Standard Equipment

- For non-combustible protective and reactive gases argon, nitrogen and forming gas (observe national regulations)
- Protective gas box with fiber seal and cover with locks, inert gas introduction via a pipe into the bottom of the box
- Protective gas connection via quick coupling with hose connector (inner diameter 9 mm)
- Piping for gas inlet and outlet through the furnace collar
- Models NA 250/.. and NA 500/.. will be delivered without bottom frame sheet
- Heat-resistant alloy: 309 (AISI)/(DIN material no. 1.4828)
- Charge thermocouple type K for temperature display or charge control

### Additional Equipment

- Gas supply systems see page 60
- Extended gas piping for the use of smaller boxes in larger furnace models
- Draw hook
- Charging cart see page 62

Article no. (Furnace with hinged door)	Furnace (Furnace with lift door)	Furnace	Inner dimensions in mm			Outer dimensions in mm <sup>1</sup>			Charging method of the box
			w	d	h	W	D	H	
631000411	631000764	NA 60/..	270	420	260	336	460	340	draw hook
631000412	631000765	NA 120/..	350	520	340	436	560	430	draw hook
631000413	631000766	NA 250/..	480	630	460	546	680	600	charging stacker
631000414	631000767	NA 500/..	630	780	610	696	836	760	charging stacker

Article no. 601655055, 1 set of fiber insulation cord, 5 strips of 610 mm each

Work space = box inner dimensions: - 30 mm to all sides

Larger boxes and custom dimensions available upon request

<sup>1</sup> Without piping



Automatic gas supply system



Protective gas box which stays in the furnace



Protective gas box with extended piping for usage in a large furnace model

## Protective Gas Boxes with Evacuation Lid for Models NA 120/45 - NA 675/85

Design as the boxes described above, but with additional evacuation lid and connection. Before the box is placed in the furnace, in a cold state an evacuation and protective gas atmosphere are alternately generated to force out the oxygen and achieve a pure atmosphere.



Protective gas box with evacuation lid

### Standard Equipment

- Protective gas box with fiber sealing and lid with locks, recess for evacuation lid, gas inlet via a pipe into the bottom of the box
- Evacuation lid with rubber sealing (Elastomer) and manometer
- Protective gas connection via three-way ball valve and quick coupling with hose connector (inner diameter 9 mm)
- Piping for gas inlet and outlet through the furnace collar

### Additional Equipment

- Vacuum pump see page 61
- Gas supply systems see page 60
- Extended gas piping for the use of smaller boxes in larger furnace models
- Draw hook
- Charging cart see page 62

Article no. (Furnace with hinged door)	(Furnace with lift door)	Furnace	Inner dimensions in mm			Outer dimensions in mm <sup>1</sup>			Charging method of the box
			w	d	h	W	D	H	
631000560	631000807	NA 60/..	230	380	220	318	468	297	draw hook
631000561	631000808	NA 120/..	330	480	320	418	568	412	draw hook
631000562	631000809	NA 250/..	430	580	370	518	668	532	charging stacker
631000563	631000810	NA 500/..	560	810	530	648	898	692	charging stacker

Article no. 601655055, 1 set of fiber insulation cord, 5 strips of 610 mm each

Work space = box inner dimensions: - 30 mm to all sides

Larger boxes and custom dimensions available upon request

<sup>1</sup> Without piping and evacuation lid

# Protective Gas Boxes for Automotive (CQI-9) and Aeronautic (AMS/NADCAP) Norms

## Protective Gas Boxes According to AMS2750F, Instrumentation Type D for Forced Convection Furnaces

These boxes are based on the standard protective gas boxes for furnaces with hinged door. To fulfill AMS2750F, instrumentation, type D requirements the boxes are equipped with necessary measuring ports.

### Standard Equipment

- Temperature uniformity class 2: +/- 5 °C in useful space
- Additional port for customers flexible SAT thermocouple with max. 1,5 mm diameter
- Thermocouple, overtemperature protection, metal clad thermocouple, type N with plug

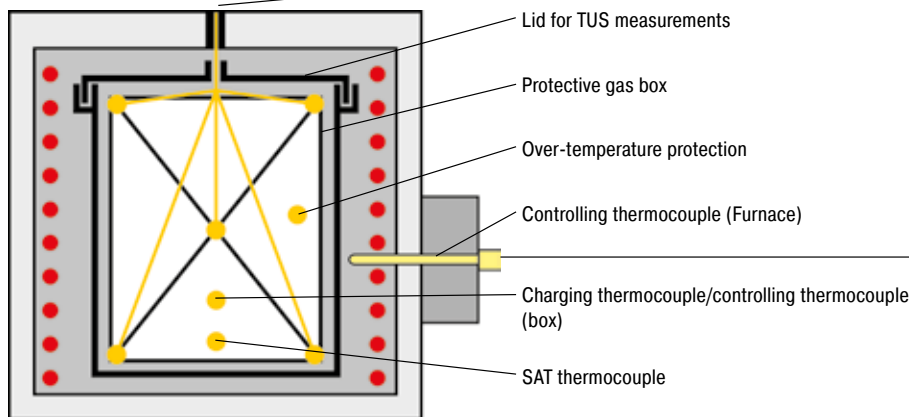

Controller

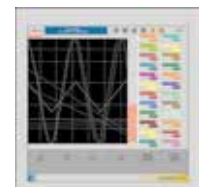

TUS recorder



TUS Measuring Frame for Protective Gas Box

To carry out the temperature uniformity measurement (TUS) the protective gas box will be equipped with a second lid. The TUS measuring frame is fixed to the lid and it is equipped with measuring port for thermocouples.

### Standard Equipment

- Tmax 1100 °C
- Useful for all relevant TUS norms
- Under the assumption that the furnace is equipped with a measuring port for thermocouples
- Heat-resistant alloy 314 (AISI)/(DIN material no. 1.4828)

Article no. (Furnace with swinging door)	Article no. (Furnace with lift door)	Furnace	Inner dimensions in mm			Outer dimensions in mm <sup>1</sup>		
			w	d	h	W	D	H
631001021	631001026	NA 60/..	270	420	260	336	460	340
631001022	631001027	NA 120/..	350	520	340	436	560	430
631001023	631001028	NA 250/..	480	630	460	546	680	600
631001024	631001029	NA 500/..	630	780	610	696	836	760

Article no. 601655055, 1 set of fiber insulation cord, 5 strips of 610 mm each

Work space = box inner dimensions: - 30 mm to all sides

Larger boxes and custom dimensions available upon request

<sup>1</sup> Without piping

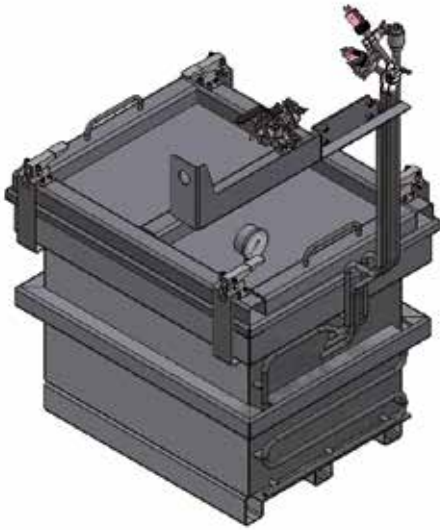

Protective gas box with evacuation lid according to AMS2750F

### Protective Gas Boxes with Evacuation Lid According to AMS2750F, Instrumentation type D

These boxes are based on the standard protective gas boxes with evacuation lid for furnaces with hinged door. Before the box is placed in the furnace, in a cold state an evacuation and protective gas atmosphere are alternately generated to force out the oxygen and achieve a pure atmosphere.

#### Standard Equipment

- Temperature uniformity class 2: +/- 5 °C in useful space
- Additional port for customers flexible SAT thermocouple with max. 1,5 mm diameter
- Thermocouple, overtemperature protection, metal clad thermocouple, type N with plug

Article no. (Furnace with hinged door)	Article no. (Furnace with lift door)	Furnace	Inner dimensions in mm			Outer dimensions in mm <sup>1</sup>		
			w	d	h	W	D	H
631001053	631001058	NA 60/..	230	380	220	318	468	297
631001052	631001057	NA 120/..	330	480	320	418	568	412
631001051	631001056	NA 250/..	430	580	370	518	668	532
631001050	631001055	NA 500/..	560	810	530	648	898	692

Article no. 601655055, 1 set of fiber insulation cord, 5 strips of 610 mm each  
 Work space = box inner dimensions: - 30 mm to all sides  
 Larger boxes and custom dimensions available upon request

<sup>1</sup> Without piping



## Forced Convection Chamber Furnaces – Tabletop Design electrically heated

These forced convection chamber furnaces are characterized by their extremely high temperature uniformity. Due to the compact tabletop design, this series is very well suited for installation in laboratories or rooms with limited space.

Applications include preheating of components for shrink-fit processes, heat treatment of metals in air such as aging, stress relieving, soft annealing or tempering, and heat treatment of glass.



Forced convection chamber furnace NAT 15/85 with base frame as additional equipment

### Standard Equipment

- Tmax 650 °C or 850 °C
- Horizontal air circulation with optimum distribution through stainless steel baffles
- Dual shell housing made of textured stainless steel sheets with additional fan cooling for low surface temperature
- Integrated control unit
- Swing door hinged on the right side, door opening temperatures up to 400 °C
- Temperature uniformity up to  $\pm 6$  °C according to DIN 17052-1 (model NAT 15/65 up to  $\pm 5$  °C) see page 72
- Optimum air distribution enabled by high flow speeds
- Air inlet in the rear wall of the furnace
- Adjustable exhaust port in the furnace ceiling (not for model NAT 15/65)
- 15 mm port in the furnace ceiling (not for model NAT 15/65)
- Controller with touch operation B500/B510 (5 programs with 4 segments each), controls description see page 76



Forced convection chamber furnace NAT 30/65

### Additional Equipment (not for NAT 15/65)

- Base frame
- Charging racks for loading on several levels
- Equipment package with batch control and process control and documentation via VCD software package



Forced convection chamber furnace NAT 30/85



Forced convection chamber furnace NAT 50/85

Model	Tmax °C	Inner dimensions in mm			Volume in l	Outer dimensions <sup>1</sup> in mm			Heating power in kW <sup>2</sup>	Electrical connection*	Weight in kg	Heat-up time <sup>3</sup> to Tmax in minutes
		w	d	h		W	D	H				
NAT 15/65	650	295	340	170	15	470	790	460	2,8	1-phase	60	40
NAT 30/65	650	320	320	300	30	810	620	620	3,0	1-phase	90	80
NAT 60/65	650	400	400	400	60	890	700	720	3,0	1-phase	110	100
NAT 15/85	850	320	320	150	15	690	880	570	3,0	1-phase	85	190
NAT 30/85	850	320	320	300	30	690	880	720	3,0	1-phase	100	230
NAT 50/85	850	400	320	400	50	770	880	820	4,5	3-phase	130	230

<sup>1</sup>External dimensions vary when furnace is equipped with additional equipment. Dimensions on request.

<sup>2</sup>Depending on furnace design connected load might be higher

<sup>3</sup>Approx. information in empty furnace

\*Please see page 80 for more information about supply voltage



Adjustable exhaust port in the furnace ceiling



Forced convection chamber furnace NAT 15/85



Interior made of stainless steel sheet 1.4828

## Ovens electrically heated

With their maximum working temperature of up to 300 °C and forced air circulation, the ovens achieve a very good temperature uniformity. They can be used for various applications such as e.g. drying, sterilizing or warm storing. Short delivery times from stock are ensured for standard models.



Oven TR 240



Oven TR 450

### Standard Equipment

- Tmax 300 °C
- Working temperature range: + 20 °C above room temperature up to 300 °C
- Ovens TR 30 - TR 420 designed as tabletop models
- Ovens TR 450 - TR 1050 designed as floor standing models
- Horizontal forced air circulation results in temperature uniformity according to DIN 17052-1 better than +/- 5 °C in the empty work space (with closed exhaust air flap) see page 72
- Stainless steel furnace housing, material no. 1.4016 (DIN)
- Stainless steel chamber, alloy 304 (AISI)/(DIN material no. 1.4301), rust-resistant and easy to clean
- Charging in multiple layers possible using removeable grids (number of removeable grids included, see table to the right)
- Large, wide-opening swing door, hinged on the right with quick release for models TR 30 - TR 240 and TR 450
- Double swing door with quick release for models TR 420, TR 800 and TR 1050
- Ovens TR 800 and TR 1050 equipped with transport castors
- Infinitely adjustable exhaust at the rear wall with operation from the front
- PID microprocessor control with self-diagnosis system
- Controller R7, alternative programmable controllers see page 80
- Solid state relays provide for lownoise operation

### Additional Equipment

- Over-temperature limiter with adjustable cutout temperature as temperature limiter to protect the oven and load
- Fan speed of the air circulation fan can be reduced infinitely
- Window for charge observing
- Further removeable grids with rails
- Side inlet
- Electrical rotary device (associated sample holder will be individually adapted to the charge)
- Exhaust air duct DN 80
- Transport castors for models TR 240 - TR 450
- Upgrading available to meet the quality requirements of AMS2750G or FDA
- Fresh-air filter to reduce dust inside the furnace





Oven TR 420



Oven TR 1050 with double door

Model	Tmax in °C	Inner dimensions in mm			Volume in l	Outer dimensions <sup>1</sup> in mm			Connected load in kW	Electrical connection*	Weight in kg	Minutes to Tmax <sup>2</sup>	Grids included	Grids max.	Max. total load <sup>3</sup>
		w	d	h		W	D	H							
TR 30	300	360	300	300	30	610	570	670	2.1	1-phase	45	25	1	4	80
TR 60	300	450	390	350	60	700	665	720	3.1	1-phase	90	25	1	4	120
TR 120	300	650	390	500	120	900	665	870	3.1	1-phase	120	45	2	7	150
TR 240	300	750	550	600	240	1000	840	970	3.1	1-phase	165	60	2	8	150
TR 420	300	1300	550	600	420	1550	910	990	6.3	3-phase	250	60	2	8	200
TR 450	300	750	550	1100	450	1000	840	1470	6.3	3-phase	235	60	3	15	180
TR 800	300	1200	680	1000	800	1470	1170	1520	6.3	3-phase	360	80	3	10	250
TR 1050	300	1200	680	1400	1050	1470	1170	1920	9.3	3-phase	450	80	4	14	250

<sup>1</sup>External dimensions vary when furnace is equipped with additional equipment. Dimensions on request.

<sup>2</sup>In the empty and closed oven, connected to 230 V 1/N/PE resp. 400 V 3/N/PE

<sup>3</sup>Max load per layer 30 kg

\*Please see page 80 for more information about supply voltage



Oven TR 30 with observation window



Extricable metal grids to load the oven in different layers



Electrical rotating device (in this case with tailored platform for PARR autoclave containers)

## Chamber Ovens electrically heated

The chamber ovens of the KTR range can be used for complex drying processes and heat treatment of charges to an application temperature of 260 °C. The high-performance air circulation enables optimum temperature uniformity throughout the work space. A wide range of accessories allow the chamber ovens to be modified to meet specific process requirements.



Chamber oven KTR 6125



Direct gas-firing at a chamber oven



KTR 4500 with platform bogie, interior lighting and inspection windows

### Standard Equipment

- Tmax 260 °C
- Electrically heated (via a heating register with integrated chrome steel heating elements)
- Temperature uniformity up to  $\pm 3$  °C according to DIN 17052-1 (for design without track cutouts) see page 72
- High-quality mineral wool insulation provides for outer temperatures of  $< 25$  °C above room temperature
- Incl. floor insulation
- High air exchange for fast drying processes
- Double-wing door for furnaces KTR 2300 and larger
- Over-temperature limiter with adjustable cutout temperature as temperature limiter to protect the oven and load
- Controller with touch operation B500 (5 programs with 4 segments each), controls description see page 76

### Additional Equipment

- Direct or indirect gas-fired
- Base frame to charge the oven via a charging forklift
- Additional door in the back for charging from both sides or to use the oven as lock between two rooms
- Fan system for faster cooling with manual or motor-driven control of the exhaust flaps
- Programmed opening and closing of exhaust air flaps
- Air circulation with speed control, recommendable for processes with light or sensitive charge
- Observation window and furnace chamber lighting
- Design for clean room heat treatment processes
- Rotating systems e. g. for tempering processes
- All KTR-models are also available with Tmax 300 °C

### Accessories

- Adjustable plate shutters to adapt the air guide to the charge and improve temperature uniformity
- Guide-in tracks and shelves
- Shelves with 2/3 extraction with evenly distributed load on the whole shelf surface
- Platform cart in combination with drive-in tracks
- Charging cart with rack system in combination with drive-in tracks
- Sealing shoes for ovens with drive-in tracks to improve temperature uniformity in the work space



Motor-driven rotary rack with baskets for moving the charge during heat treatment



Chamber oven KTR 6250 with double doors in the front and in the back as well as guide-in tracks for use as sluice oven

Model	Tmax °C	Inner dimensions in mm			Volume in l	Outer dimensions <sup>2</sup> in mm			Heating power in kW <sup>1</sup>	Electrical connection*
		w	d	h		W	D	H		
KTR 1000	260	1000	1000	1000	1000	1820	1430	1890	18	3-phase
KTR 1500	260	1000	1000	1500	1500	1820	1430	2390	18	3-phase
KTR 2000	260	1100	1500	1200	2000	1920	1930	2090	18	3-phase
KTR 2300	260	1250	1250	1500	2300	2120	1680	2460	27	3-phase
KTR 3100	260	1250	1250	2000	3100	2120	1680	2960	27	3-phase
KTR 3400	260	1500	1500	1500	3400	2370	1930	2460	45	3-phase
KTR 4500	260	1500	1500	2000	4500	2370	1930	2960	45	3-phase
KTR 4600	260	1750	1750	1500	4600	2620	2175	2480	45	3-phase
KTR 6000	260	2000	2000	1500	6000	2870	2430	2460	54	3-phase
KTR 6125	260	1750	1750	2000	6125	2620	2175	2980	45	3-phase
KTR 6250	260	1250	2500	2000	6250	2120	3035	2960	54	3-phase
KTR 8000	260	2000	2000	2000	8000	2870	2430	2960	54	3-phase
KTR 9000	260	1500	3000	2000	9000	2490	3870	2920	72	3-phase
KTR 12300	260	1750	3500	2000	12300	2620	4350	2980	90	3-phase
KTR 13250	260	1250	5000	2000	13250	2120	6170	2960	108	3-phase
KTR 16000	260	2000	4000	2000	16000	2870	4850	2960	108	3-phase
KTR 21300	260	2650	3550	2300	21300	3600	4195	3380	108	3-phase
KTR 22500	260	2000	4500	2500	22500	3140	5400	3500	108	3-phase

<sup>1</sup>Depending on furnace design connected load might be higher

<sup>2</sup>External dimensions vary when furnace is equipped with additional equipment. Dimensions on request.

\*Please see page 80 for more information about supply voltage



Adjustable plate shutters to adapt the air guide to the charge

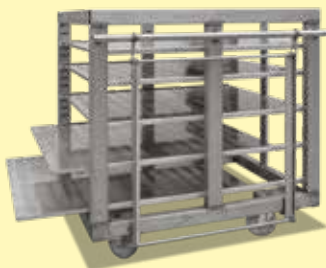

Charging cart with pull-out trays



Pull-out shelves, running on rolls

# Chamber Furnaces with Brick Insulation or Fiber Insulation

Furnaces with robust insulation made of light-weight refractory bricks for rough industrial use.



Dual shell housing made of textured stainless steel sheets with additional fan cooling for low surface temperature



Solid state relays provide for low noise operation



Exclusive use of insulation materials without categorization according to EC Regulation No 1272/2008 (CLP). This explicitly means that aluminosilicate wool, also known as “refractory ceramic fiber” (RCF), which is classified and possibly carcinogenic, is not used.



NTLog Basic for Nabertherm controller: recording of process data with USB-flash drive



Defined application within the constraints of the operating instructions



As additional equipment: Process control and documentation via VCD software package for monitoring, documentation and control



Furnace Group	Model	Page
Chamber furnaces	LH 15/.. - LH 216/..	46
Protective gas boxes and charging plates	LH 15/.. - LH 216/..	48
Chamber furnaces with drawer bottom or as a bogie	NW 150 - NW 1000	50
Protective gas boxes and protective gas hoods for chamber furnaces	NW 150 - NW 1000	51
Chamber furnaces	N 7/H - N 641/13	52
Protective gas boxes and charging plates	N 7/H - N 641/13	55
Charging forks		57

## Chamber Furnaces with Brick Insulation or Fiber Insulation

The chamber furnaces LH 15/12 - LF 120/14 have been trusted for many years as professional chamber furnaces for the laboratory. These furnaces are available with either a robust insulation of light refractory bricks (LH models) or with a combination insulation of refractory bricks in the corners and low heat storage, quickly cooling fiber material (LF models). With a wide variety of optional equipment, these chamber furnaces can be optimally adapted to your processes.



Chamber furnace LH 216/12 with fresh air fan to accelerate the cooling times

### Standard Equipment

- Tmax 1200 °C, 1300 °C, or 1400 °C
- Dual shell ventilated housing made of textured stainless steel sheets for low surface temperature and high stability
- High furnace chamber with five-sided heating for very good temperature uniformity
- Heating elements on support tubes ensure free heat radiation and a long service life
- Controller mounted on furnace door and removable for comfortable operation
- Protection of bottom heating and flat stacking surface provided by embedded SiC plate in the floor
- LH models: multi-layered insulation of light refractory bricks and special backup insulation
- LF models: high-quality fiber insulation with corner bricks for shorter heating and cooling times
- Motorized exhaust air flap
- Freely adjustable air inlet integrated in furnace floor
- Base included
- Controller with touch operation C540 (10 programs with each 20 segments), alternative controllers see page 80



LH 60/13 DB50 for debinding in air

### Additional Equipment

- Parallel swinging door (user protected from heat radiation)
- Lift door with electro-mechanic linear drive for opening when hot
- Cooling system to cool the furnace with a defined temperature gradient or with a preset fresh air volume. Both operating modes can be switched on and off for different segments by means of the extra function of the controller.
- Protective gas connection to purge with non-flammable process gases
- Manual or automatic gas supply system
- Stainless steel exhaust hood as interface to customer's exhaust system



Chamber furnace LH 30/12 with manual lift door



Chamber furnace LF 60/14

Model	Tmax in °C	Inner dimensions in mm			Volume in l	Outer dimensions <sup>1</sup> in mm			Connected load in kW	Electrical connection*	Weight in kg
		w	d	h		W	D	H			
LH 15/12	1200	250	250	250	15	680	860	1230	5	3-phase <sup>2</sup>	170
LH 30/12	1200	320	320	320	30	710	930	1290	7	3-phase <sup>2</sup>	200
LH 60/12	1200	400	400	400	60	790	1180	1370	8	3-phase	300
LH 120/12	1200	500	500	500	120	890	1180	1470	12	3-phase	410
LH 216/12	1200	600	600	600	216	990	1280	1590	20	3-phase	470
LH 15/13	1300	250	250	250	15	680	860	1230	7	3-phase <sup>2</sup>	170
LH 30/13	1300	320	320	320	30	710	930	1290	8	3-phase <sup>2</sup>	200
LH 60/13	1300	400	400	400	60	790	1180	1370	11	3-phase	300
LH 120/13	1300	500	500	500	120	890	1180	1470	15	3-phase	410
LH 216/13	1300	600	600	600	216	990	1280	1590	22	3-phase	470
LH 15/14	1400	250	250	250	15	680	860	1230	8	3-phase <sup>2</sup>	170
LH 30/14	1400	320	320	320	30	710	930	1290	10	3-phase <sup>2</sup>	200
LH 60/14	1400	400	400	400	60	790	1180	1370	12	3-phase	300
LH 120/14	1400	500	500	500	120	890	1180	1470	18	3-phase	410
LH 216/14	1400	600	600	600	216	990	1280	1590	26	3-phase	470
LF 15/13	1300	250	250	250	15	680	860	1230	7	3-phase <sup>2</sup>	150
LF 30/13	1300	320	320	320	30	710	930	1290	8	3-phase <sup>2</sup>	180
LF 60/13	1300	400	400	400	60	790	1180	1370	11	3-phase	270
LF 120/13	1300	500	500	500	120	890	1180	1470	15	3-phase	370
LF 15/14	1400	250	250	250	15	680	860	1230	8	3-phase <sup>2</sup>	150
LF 30/14	1400	320	320	320	30	710	930	1290	10	3-phase <sup>2</sup>	180
LF 60/14	1400	400	400	400	60	790	1180	1370	12	3-phase	270
LF 120/14	1400	500	500	500	120	890	1180	1470	18	3-phase	370

<sup>1</sup>External dimensions vary when furnace is equipped with additional equipment. Dimensions on request.

<sup>2</sup>Heating only between two phases

\*Please see page 80 for more information about supply voltage



Parallel swinging door for opening when hot



Model with brick base



LF furnace design provides for shorter heating and cooling times

## Protective Gas Boxes for Models LH 15/.. - LH 216/..

Due to the cubic interior of the LH chamber furnaces and the corresponding protective gas boxes, these furnaces are ideally suited for higher batches. Gassing boxes for the LH models have a standard charge thermocouple, which can be used, for example, for charge control. The protective gas inlet and outlet is routed through the furnace collar in the case of a furnace with a swivel door on the left and through the lower furnace collar in the lift-door configuration. These boxes have a lid for charging from above, protective gas inlet and outlet.

### Standard Equipment

- Tmax 1100 °C
- For non-combustible protective and reactive gases argon, nitrogen and forming gas (observe national regulations)
- Protective gas box with fiber seal and cover with locks, inert gas introduction via a pipe into the bottom of the box
- Protective gas connection via quick coupling with hose connector (inner diameter 9 mm)
- Piping for gas inlet and outlet through the furnace collar
- Heat-resistant alloy 314 (AISI)/(DIN material no. 1.4841)
- Charge thermocouple type K for temperature display or charge control



Protective gas box for furnaces with hinged door

### Additional Equipment

- Starting from LH 30/.. a charging cart is recommended see page 62
- Gas supply systems see page 60
- Extended gas piping for the use of smaller boxes in larger furnace models
- Draw hook
- Charging stacker see page 63

Article no.	Furnace	Inner dimensions in mm			Outer dimensions in mm <sup>1</sup>			Charging method of the box
		w	d	h	W	D	H	
631001276	LH 15/..	100	100	100	165	182	166	draw hook
631001277	LH 30/..	170	170	170	235	252	236	draw hook
631001278	LH 60/..	250	250	250	315	332	316	draw hook
631001279	LH 120/..	350	350	350	415	411	441	draw hook
631001280	LH 216/..	450	450	400	514	535	554	charging stacker

Article no. 601655055, 1 set of fiber insulation cord, 5 strips of 610 mm each

Work space = box inner dimensions: - 30 mm to all sides

Larger boxes and custom dimensions available upon request

<sup>1</sup> Without piping



Protective gas box which stays in the furnace

### Protective Gas Boxes with Charging from the Front

Design as the described protective gas boxes, but with charging from the front. These protective gas boxes remain in the oven and are equipped with a lid that can be opened to the front. After the lid has been opened, the batch can be removed directly.

Article no.	Furnace	Inner dimensions in mm			Outer dimensions in mm <sup>1</sup>			Charging method of the box
		w	d	h	W	D	H	
631001310	LH 15/..	100	100	100	170	148	194	-
631001311	LH 30/..	170	170	170	240	218	264	-
631001312	LH 60/..	250	250	250	320	298	344	-
631001313	LH 120/..	350	350	350	420	398	444	-

Article no. 601655055, 1 set of fiber insulation cord, 5 strips of 610 mm each

Work space = box inner dimensions: - 30 mm to all sides

Larger boxes and custom dimensions available upon request

<sup>1</sup> Without piping



## Protective Gas Boxes with Evacuation Lid for Models LH 15/.. - LH 216/..

Design as the described protective gas boxes, but with an additional evacuation lid. In order to reduce the residual oxygen in the box, protective gas boxes with evacuation lids can be used. These boxes have a lid for top loading, a protective gas inlet and outlet, and an evacuation cover with rubber gasket. The gas piping and the handling in the warm state corresponds to the gassing boxes on page 48. In addition, a connection for a vacuum pump via three-way ball valve is provided.

In combination with a vacuum pump, the oxygen is evacuated from the box in cold state and afterwards flushed with protective gas. Repeating the process once or several times will significantly improve the results. After this process, the evacuation cover is removed and the actual heat treatment process is started under protective gas. After the heat treatment, the box is pulled out of the furnace and can be cooled in air or opened for batch removal.

### Standard Equipment

- Protective gas box with fiber sealing and lid with locks, recess for evacuation lid, gas inlet via a pipe into the bottom of the box
- Evacuation lid with rubber sealing (Elastomer) and manometer
- Protective gas connection via threeway ball valve and quick coupling with hose connector (inner diameter 9 mm)

### Additional Equipment

- Vacuum pump see page 61
- Gas supply systems see page 60
- Extended gas piping for the use of smaller boxes in larger furnace models
- Draw hook, starting from LH 30/.. a charging cart is recommended see page 62
- Charging stacker see page 63



Protective gas box with evacuation lid

Article no.	Furnace	Inner dimensions in mm			Outer dimensions in mm <sup>1</sup>			Charging method of the box
		w	d	h	W	D	H	
631001281	LH 15/..	100	100	100	152	180	160	draw hook
631001282	LH 30/..	170	170	170	222	252	230	draw hook
631001283	LH 60/..	250	250	250	302	332	310	draw hook
631001284	LH 120/..	350	350	350	402	432	405	draw hook
631001285	LH 216/..	450	450	400	506	535	540	charging stacker

Article no. 601655055, 1 set of fiber insulation cord, 5 strips of 610 mm each  
 Work space = box inner dimensions: - 30 mm to all sides  
 Larger boxes and custom dimensions available upon request

<sup>1</sup> Without piping and evacuation lid

## Charging Plates for Models LH 15/.. - LH 216/..

Charging plates are recommended to protect the furnace floor. The charging plates are particularly suitable for heat treatment with protective gas boxes in order to minimize wear during charging.

### Standard Equipment

- Tmax 1100 °C
- Threeside upstand
- Heat-resistant alloy 314 (AISI)/(DIN material no. 1.4841)
- With spacer on the rear heating elements



Charging plate

Article no.	Furnace	Outer dimensions in mm		
		W	D	H
628002013	LH 15/..	190	230	30
628002014	LH 30/..	260	300	30
628002015	LH 60/..	340	400	30
628002016	LH 120/..	440	500	30
628002017	LH 216/..	540	600	30

## Chamber Furnaces with Drawer Bottom or as a Bogie

The NW chamber furnaces enable simple charging for cold-cold processes. The heat treatment can take place under air or under non-flammable protective gases with a protective gas box or protective gas hood. With a drawer mechanism (NW 150 - NW 300/H) the furnace table can be easily pulled out of the chamber furnace. The larger models NW 440 - NW 1000/H are designed as shuttle furnace with completely free traversing bogie. Free access in front of the furnace allows for a simplified and clear charging.



Chamber kiln NW 300



Chamber kiln NW 440

### Standard Equipment

- Tmax 1300 °C, 1100 °C with protective gas box (additional equipment)
- Dual shell housing, galvanized steel sheets
- Double-walled door with front made of textured stainless steel
- Controller mounted on furnace door and removable for comfortable operation (up to model NW 440)
- Heating from five sides with special arrangement of heating elements for optimum temperature uniformity
- Heating elements of support tubes provide for free radiation of the heat
- Multi-layer insulation with light-weight refractory bricks and high-quality, energy-saving backing insulation
- Exclusive use of insulation materials without categorization according to EC Regulation No 1272/2008 (CLP). This explicitly means that aluminosilicate wool, also known as "refractory ceramic fiber" (RCF), which is classified and possibly carcinogenic, is not used.
- Vaulted ceiling
- Furnace table can be pulled-out as drawer (NW 150 - NW 300)
- From chamber furnace NW 440 bogie on four castors (two with brakes) which can be pulled out completely. Accession assistance and removable drawbar for bogie
- SiC-floor plate protects floor elements and provides a level setting surface
- Door sealing grinded by hand (brick on brick); NW 150 - NW 300
- Semi-automatic air inlet flap closes the air inlet at a temperature which can be set in the controller for NW 150 - NW 300
- Exhaust air outlet in the ceiling, motorized exhaust air flap for chamber furnaces NW 440 - NW 1000
- Comfortable charging height with base of 800 mm (chamber furnaces NW 440 - NW 1000 = 500 mm)
- Defined application within the constraints of the operating instructions
- NTLog for Nabertherm controller: recording of process data with USB-flash drive
- Controls description see page 76

### Additional Equipment

- Protective gas boxes and hoods
- Manual or automatic gas supply system
- Process control and documentation via VCD software package or Nabertherm Control Center (NCC) for monitoring, documentation and control see page 76

Model	Tmax °C	Inner dimensions in mm			Volume in l	Outer dimensions <sup>1</sup> in mm			Connected load kW	Electrical connection*	Weight in kg
		w	d	h		W	D	H			
NW 150	1300	430	530	620	150	790	1150	1600	11.0	3-phase	400
NW 200	1300	500	530	720	200	860	1150	1700	15.0	3-phase	460
NW 300	1300	550	700	780	300	910	1320	1760	20.0	3-phase	560
NW 440	1300	600	750	1000	450	1000	1400	1830	30.0	3-phase	970
NW 660	1300	600	1100	1000	660	1000	1750	1830	40.0	3-phase	1180
NW 1000	1300	800	1000	1250	1000	1390	1760	2000	57.0	3-phase	1800

\*Please see page 80 for more information about supply voltage

<sup>1</sup>External dimensions vary when furnace is equipped with additional equipment. Dimensions on request.

# Protective Gas Boxes and Protective Gas Hoods for Chamber Furnaces

## NW 150 - NW 1000



Chamber furnace NW 200 with protective gas box



Protective gas box for similar furnace



Two automatic gas supply systems, connected with each other

### Protective Gas Boxes

These protective gas boxes have a cover with a sealing profile as well as a protective gas inlet and outlet. They are pulled out of the furnace in cold condition and charged from above.

#### Standard Equipment

- Tmax 1100 °C
- For non-combustible protective and reactive gases argon, nitrogen and forming gas (observe national regulations)
- Protective gas box with fiber seal and cover with locks, inert gas introduction via a pipe into the bottom of the box
- Protective gas connection via quick coupling with hose connector (inner diameter 9 mm)
- Piping for gas inlet and outlet through the furnace collar
- Forklift receptive
- Heat-resistant alloy 314 (AISI)/(DIN material no. 1.4841)
- Charge thermocouple type K for temperature display or charge control

### Protective Gas Hoods

Protective gas hoods consist of a top and a bottom with a sealing profile as well as protective gas inlet and outlet. After charging the bottom in front of the oven in cold condition, the hood is put on and the drawer or the car is pushed back into the oven.

#### Design as Protective Gas Boxes, but

- Gassing hood with eye for raising the hood by crane
- Hood bottom with sealing
- Piping for gas inlet and outlet at the hood through the furnace collar

#### Additional Equipment

- Gas supply systems see page 60

Furnace	Article no. Protective gas box	Inner dimensions in mm			Article no. Protective gas hood	Inner dimensions in mm			Charging the furnace
		w	d	h		w	d	h	
NW 150	631001329	330	420	400	631001334	300	360	400	drawer
NW 200	631001330	400	420	500	631001335	370	360	450	drawer
NW 300	631001331	450	550	550	631001336	420	530	500	drawer
NW 440	631001332	500	600	750	631001337	470	580	550	on a bogie
NW 660	631001333	500	750	750	631001338	470	750	550	on a bogie
NW 1000					on request				on a bogie

Article no. 601655055, 1 set of fiber insulation cord, 5 strips of 610 mm each

Work space = box inner dimensions: - 30 mm to all sides

Larger boxes and custom dimensions available upon request

## Chamber Furnaces electrically heated

These universal chamber furnaces with radiation heating have been specifically designed to withstand heavy-duty use in the tool shop and industry. They are particularly useful for processes such as tool making or for hardening jobs, e.g. annealing, hardening and forging. With help of various accessories, these furnaces can be customized to every application requirements.



Annealing furnace N 7/H, as table-top model with optional protective gas box



Chamber furnace N 41/H with optional protective gas box

### Standard Equipment

- Compact, robust design construction with double-walled housing
- Door can be opened when furnace is hot
- Deep furnace chamber with three-sides heating: from both side walls and bottom
- Heating elements on support tubes ensure free heat radiation and a long service life
- Bottom heating protected by heat-resistant SiC plate (models N 81/.. - N 641/.. also with side SiC plates)
- Stainless steel upper door jamb protects furnace structure when furnace is opened hot up to model N 87/H. Models N 81/... - N 641/.. with compact stainless steel door.
- Temperature uniformity up to  $\pm 10$  °C according to DIN 17052-1 see page 72
- Low energy consumption due to multi-layer insulation
- Base frame included in the delivery, N 7/H - N 17/HR designed as table-top model
- Exhaust opening in the side of the furnace, or on rear wall of chamber furnace in the N 31/H models and higher
- Parallel swinging door (user protected from heat radiation) up to N 87/H guided downwards, from N 81 guided upwards
- Door movement cushioned with gas dampers/struts
- Heat resistant zinc paint for protection of door and door frame (for model N 81 and larger)
- NTLog Basic for Nabertherm controller: recording of process data with USB-flash drive
- Controller with touch operation B500 (5 programs with 4 segments each), controls description see page 76
- Freeware NTEdit for convenient program input via Excel™ for Windows™ on the PC
- Freeware NTGraph for evaluation and documentation of firings using Excel™ for Windows™ on the PC
- MyNabertherm App for online monitoring of the firing on mobile devices for free download

### Additional Equipment

- Side heating elements protected with SiC tiles (models N 7/H - N 87/H)
- Port with 18 mm ceramic tube including screw cap (models N 7/H - N 87/H)
- Pneumatic door opening, controlled by foot pedal (models N 31/H - N 641/13)
- Protective gas boxes for heat treatment under non-flammable protective and reaction gases
- Gas feed fittings
- Charging devices
- Charge control



Chamber furnace N 87/H



Chamber furnace N 81/13 with pneumatic lift door

Model	Tmax °C	Inner dimensions in mm			Volume in l	Outer dimensions <sup>4</sup> in mm			Heating power in kW <sup>3</sup>	Electrical connection <sup>*</sup>	Weight in kg
		w	d	h		W	D	H			
N 7/H <sup>1</sup>	1280	250	250	140	9	800	650	600	3.0	1-phase	60
N 11/H <sup>1</sup>	1280	250	350	140	11	800	750	600	3.5	1-phase	70
N 11/HR <sup>1</sup>	1280	250	350	140	11	800	900	600	5.5	3-phase <sup>2</sup>	70
N 17/HR <sup>1</sup>	1280	250	500	140	17	800	900	600	6.4	3-phase <sup>2</sup>	90
N 31/H	1280	350	350	250	30	1040	1030	1340	15.0	3-phase	210
N 41/H	1280	350	500	250	40	1040	1180	1340	15.0	3-phase	260
N 61/H	1280	350	750	250	60	1040	1430	1340	20.0	3-phase	400
N 87/H	1280	350	1000	250	87	1040	1680	1340	25.0	3-phase	480
N 81	1200	500	750	250	80	1300	2000	2000	20.0	3-phase	950
N 161	1200	550	750	400	160	1350	2085	2300	30.0	3-phase	1160
N 321	1200	750	1100	400	320	1575	2400	2345	47.0	3-phase	1570
N 641	1200	1000	1300	500	640	1850	2850	2650	70.0	3-phase	2450
N 81/13	1300	500	750	250	80	1300	2000	2000	22.0	3-phase	970
N 161/13	1300	550	750	400	160	1350	2085	2300	35.0	3-phase	1180
N 321/13	1300	750	1100	400	320	1575	2400	2345	60.0	3-phase	1600
N 641/13	1300	1000	1300	500	640	1850	2850	2650	80.0	3-phase	2500

<sup>1</sup>Table-top model

<sup>2</sup>Heating only between two phases

<sup>3</sup>Depending on furnace design connected load might be higher

<sup>4</sup>External dimensions vary when furnace is equipped with additional equipment. Dimensions on request.

\*Please see page 80 for more information about supply voltage



Working with protective gas boxes for a protective gas atmosphere using a charging cart



Chamber furnace N 7/H as table-top model



Deep furnace chamber with three-sides heating

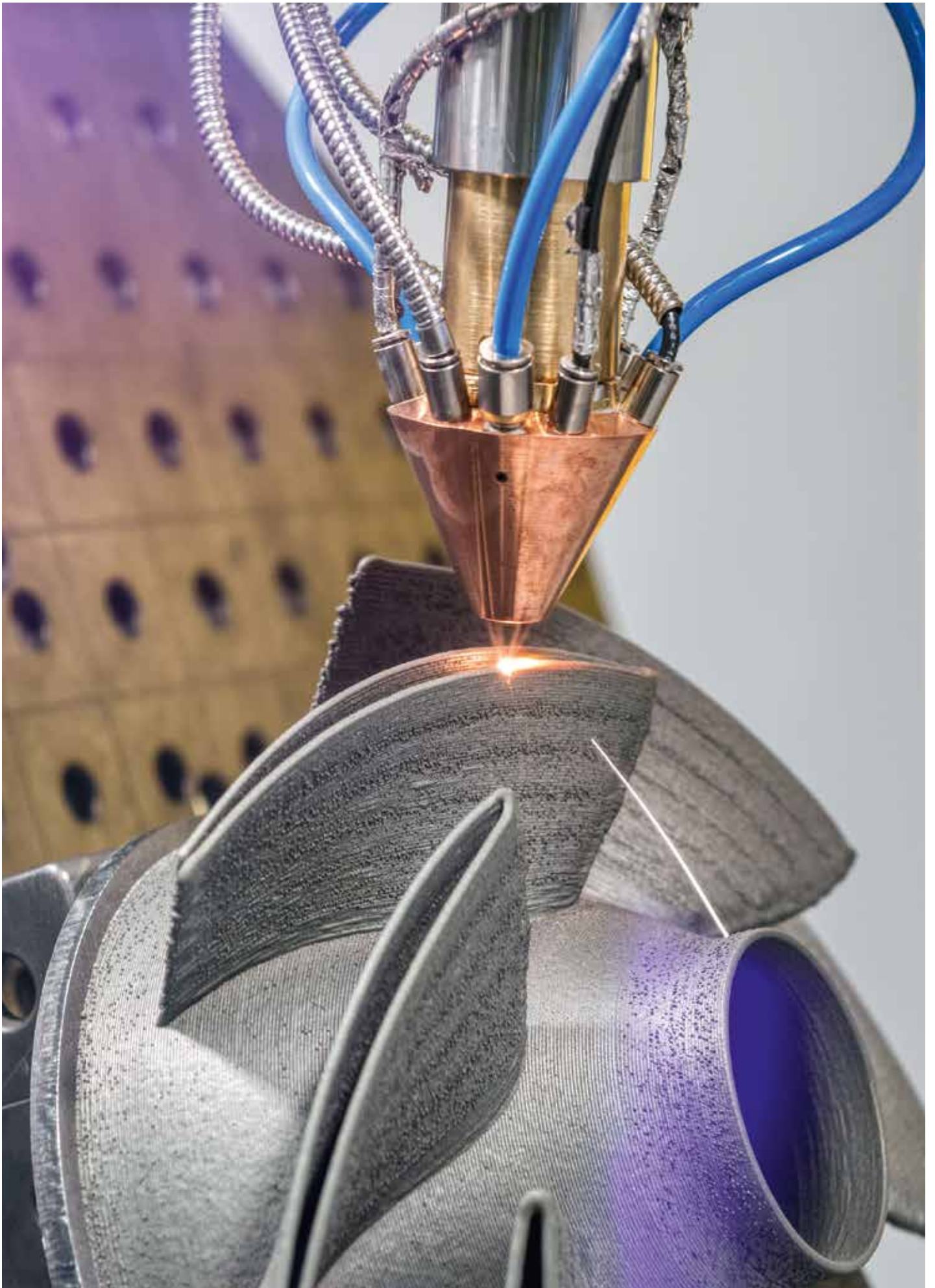

## Protective Gas Boxes for Models N 7/H - N 641/13

The annealing boxes for heat treatment under protective gas are equipped with a protective gas inlet and outlet. A box with protective gas is advisable for larger workpieces requiring defined heat treating. We would be pleased to carry out Trials at our technical center can be carried out on request. Up to furnace model N 61/H with downward door opening the gas ductway is laid through the upper section of the door collar, for larger furnaces with upward door opening the supply line is laid through the lower furnace collar.

The box is pressurized with non flammable protective and reactive gases such as argon, nitrogen or forming gas via the protective gas tube. There are manual and automatic systems available for protective gas. See pages 60 - 61. for more information about protective gases which can be used as well as manual and automatic protective gas systems.

After charging the box it is closed and preflushed outside the furnace. Afterwards the box is placed in the preheated furnace. The quantity of gas can be reduced to the process flush quantity. After the heat treatment the box is pulled out of the furnace, the charge taken from the box and placed in the quenching medium. We recommend using binding wire on the parts so that they can easily be grasped by tongs.

A flexible type K thermocouple is installed in the box for measuring the temperature; we recommend connecting it to a digital display device or to a temperature recorder.

The box can also be cooled down on a cooling platform while closed. Be sure that the protective gas flowrate is increased for this application.



Box with protective gas connection



Winch stacker with protective gas box and furnace

### Standard Equipment

- Tmax 1100 °C
- For non-combustible protective and reactive gases argon, nitrogen and forming gas (observe national regulations)
- Protective gas box with fiber sealing and lid, gas supply via a tube into the bottom of the box
- Protective gas connection via quick coupling with hose connector (inner diameter 9 mm)
- Piping for gas inlet and outlet through the furnace collar
- Heat-resistant alloy 314 (AISI)/(DIN material no. 1.4841)
- Charge thermocouple type K for temperature display or charge control

### Additional Equipment

- Starting from N 31/H a charging cart is recommended see page 62
- Gas supply systems see page 60
- Charging forks see page 57
- Draw Hook

Article no.	Furnace	Inner dimensions in mm			Outer dimensions in mm <sup>1</sup>			Preflush rate l/min	Process flush rate l/min	Charging method of the box
		w	d	h	W	D	H			
631000963	N 7/H	180	190	90	216	226	116	15 - 20	5 - 8	charging fork
631000968	N 11/H, N 11/HR	180	290	90	216	326	116	15 - 20	5 - 8	charging fork
631000973	N 17/HR	180	440	90	216	476	116	15 - 20	5 - 8	charging fork
631000978	N 31/H	280	230	200	316	304	226	20 - 25	10 - 15	draw hook
631000983	N 41/H	280	380	200	316	454	226	20 - 25	10 - 15	draw hook
631000987	N 61/H, N 87/H	280	500	200	316	574	226	20 - 25	10 - 15	draw hook
631000392	N 81, N 81/13	394	494	185	462	530	212	20 - 30	10 - 20	charging stacker
631000393	N 161, N 161/13	450	550	250	515	596	355	20 - 30	10 - 20	charging stacker
631000607	N 321, N 321/13	470	850	185	580	960	330	20 - 30	10 - 20	charging stacker
631000608	N 641, N 641/13	720	1050	270	830	1160	414	20 - 30	10 - 20	charging stacker

Article no. 601655055, 1 set of fiber insulation cord, 5 strips of 610 mm each  
 Work space = box inner dimensions: - 30 mm to all sides  
 Larger boxes and custom dimensions available upon request

<sup>1</sup> Without piping

## Protective Gas Boxes with Evacuation Lid for Models N 7/H - N 161/13

For heat treatment of bulk goods and hollow parts under protective gas atmosphere we recommend the usage of protective gas boxes with an additional evacuation lid.

These boxes are equipped with a lid for top charging, protective gas inlet and outlet as well as a evacuation lid with rubber sealing gasket. Gas ductwork and handling while hot is the same as the protective gas boxes described on page 55. In addition, these boxes also feature a connection for a vacuum pump with a shut-off valve.

After charging the box in a cold state it is evacuated and afterwards flushed with protective gas. By repeating this process once or several times the results are considerably improved. After the box was flushed with protective gas the last time, the evacuation lid is removed and the box is placed into the preheated furnace. Protective gas is used for heat treatment. Thus traces of oxygen in the box can be reduced by a considerable amount which improves the quality of the components accordingly.

After the heat treatment the box is taken out of the furnace and can be cooled in air or be opened to remove the charge.

The box can also be force-cooled on a cooling platform while closed. Be sure that the protective gas flowrate is increased for this application.

### Standard Equipment

- Tmax 1100 °C
- For non-combustible protective and reactive gases argon, nitrogen and forming gas (observe national regulations)
- Protective gas box with fiber sealing and lid with locks, recess for evacuation lid, gas inlet via a pipe into the bottom of the box
- Evacuation lid with rubber sealing (Elastomer) and manometer
- Protective gas connection via threeway ball valve and quick coupling with hose connector (inner diameter 9 mm)
- Piping for gas inlet and outlet through the furnace collar
- Heat-resistant alloy 314 (AISI)/(DIN material no. 1.4841)
- Charge thermocouple type K for temperature display or charge control

### Additional Equipment

- Starting from N 31/H a charging cart is recommended see page 62
- Vacuum pump see page 61
- Gas supply systems see page 60
- Charging forks see page 57
- Draw Hook



Protective gas box for N 41/H furnace with additional evacuation lid

Article no.	Furnace	Inner dimensions in mm			Outer dimensions in mm <sup>1</sup>			Preflush rate l/min	Process flush rate l/min	Charging method of the box
		w	d	h	W	D	H			
631000966	N 7/H	170	170	70	212	212	106	15 - 20	5 - 8	charging fork
631000971	N 11/H, N 11/HR	170	270	70	212	312	106	15 - 20	5 - 8	charging fork
631000976	N 17/HR	170	420	70	212	462	106	15 - 20	5 - 8	charging fork
631000981	N 31/H	250	200	150	292	242	178	20 - 25	10 - 15	draw hook
631000985	N 41/H	250	350	150	292	392	178	20 - 25	10 - 15	draw hook
631000989	N 61/H, N 87/H	250	500	150	292	542	178	20 - 25	10 - 15	draw hook
631000526	N 81, N 81/13	354	494	185	422	905	215	20 - 30	10 - 20	charging stacker
631000527	N 161, N 161/13	400	550	250	468	965	350	20 - 30	10 - 20	charging stacker

Article no. 601655055, 1 set of fiber insulation cord, 5 strips of 610 mm each  
Work space = box inner dimensions: - 30 mm to all sides

<sup>1</sup> Without piping and evacuation lid  
Larger boxes and custom dimensions available upon request



## Charging Plates for Models N 7/H - N 641/13

We recommend these accessories for applications up to 1100 °C to protect the furnace floor, especially if a charging cart is used.



Charging plate

### Standard Equipment

- Tmax 1100 °C
- Three raised edges
- Heat-resistant alloy 314 (AISI)/(DIN material no. 1.4841)
- Larger plates and custom dimensions available upon request

Article no.	Furnace	Outer dimensions in mm		
		W	D	H
628000138	N 7/H	240	290	25
628000139	N 11/H, N 11/HR	240	390	25
628000141	N 17/HR	240	540	30
628000400	N 31/H	340	390	30
628000133	N 41/H	340	540	30
628000142	N 61/H	340	790	30
628001925	N 87/H	340	1040	30
628000143	N 81, N 81/13	480	790	30
628000144	N 161, N 161/13	530	790	30
628000145	N 321, N 321/13	720	1140	30
628000146	N 641, N 641/13	950	1330	30

## Charging Forks

Charging forks to charge and remove protective gas boxes up to model N 17/H



Article no.	Furnace
631001016	N 7/H, N 11/H(R)
631001017	N 17/HR



# Additional Equipment Chamber and Convection Furnaces

Additional equipment such as gas supply systems for different non-combustible process gases, adapted to the gas supply boxes for the chamber and convection furnaces. Charging stackers and charging carts support loading and unloading.



Furnace Group	Page
Gas supply systems	60
Vacuum pump	61
Cooling platforms and charging devices	62

# Gas Supply Systems

## Protective Gases

Protective gases are used to force oxygen out of the gas feed boxes mentioned above. Make sure to use protective gases behaving neutrally toward the heat treated part. The protective gases should be inert, meaning no chemical bonding should occur with the workpiece or the furnace and no reactions should be induced.

In many cases, nitrogen is used as protective gas (lighter than air). Our experience shows that nitrogen does not always lead to sufficient results. A longer preflush time must also be used.

Better results are achieved by adding a mixture of nitrogen and adding some hydrogen. Hydrogen acts as a reducing constituent and reacts with the oxygen. This gas mixture is known as forming gas and available in stores. Experience has shown that adding 5 % hydrogen to the nitrogen leads to good results. According to the EU material safety data sheet this mixture is considered as not flammable. National regulations, however, must be observed. This gas can be obtained in premixed form. No measures must be taken in advance to prevent explosions.

If the workpiece has an affinity to hydrogen, argon used as protective gas can lead to good results.

Argon is a gas which is heavier than air. This makes it relatively easy to fill the protective gas containers. Forming gas with added hydrogen (depending on the country law up to a ration of 98/2) is lighter, but it has the advantage of burning at higher temperatures and therefore binds with the oxygen. Even in a cold state, the leaking hydrogen transports the oxygen very easily out of the container.

For gas mixtures with hydrogen or other combustible gases, the valid safety regulations must always be observed. If the mixture is declared as combustible, the furnace, provided it is a gas tight version, can be fitted with a corresponding safety system.

Always make sure that the room is properly ventilated when working with protective gases. Country-specific safety regulations must also be followed.



Automatic gas supply system

### Automatic gas supply system for flow rates of 4 l - 50 l/min

- Gas supply system mounted at the furnace in a compact stainless steel housing
- Gas flow can be activated in each segment by solenoid valve via the controller; Flow rate preset manually
- Gas inlet: 1 bar - 10 bar, hose connection:  $\varnothing i = 9$  mm
- Gas outlet: hose connection:  $\varnothing i = 9$  mm
- System includes:
  - Solenoid valve with connection to the controller
  - Flow meter (scale as sticker)
  - Flow rate adjustment manually by screw and needle valve
  - Pressure reducer for setting the supply pressure
  - Pressure gauge for reading the supply pressure
  - Connection set for furnace
  - 5 m connection hose 9 mm
  - Quick fitting (G1/4) for gas inlet

Article no.	Type of gas	Flow rate l/min
6000085544	gas independent	4 - 50

## Automatic Gas Supply System for Two Flow Rates 2 x 4 l - 50 l/min



Automatic gas supply system for two flushing quantities

- Gas supply systems mounted at the furnace in compact stainless steel housings
- Two combined gas supply systems depending on the connection for 2 gas quantities, 2 gas types or large gas quantity
- The gas supply can be activated in each segment by 2 solenoid valves, which can be selected independently via the controller. Gas flow rates pre-set manually
- Gas inlet: 1 bar - 10 bar, hose connection Øi = 9 mm
- Gas outlet: hose connection Øi = 9 mm
- System includes 2 combined systems, each with:
  - Solenoid valve with connection to the controller
  - Flow meter (scale as sticker)
  - Flow rate adjustment manually by screw and needle valve
  - Pressure reducer for setting the supply pressure
  - Pressure gauge for reading the supply pressure
  - Connection set for furnace
  - 5 m connection hose 9 mm
  - Quick fitting (G1/4) for gas inlet

Article no.	Type of gas	Flow rate l/min
6000085545	gas independent	2 x 4 - 50 or 4 - 100

## Gas bottle connection



Gas bottle connection

- With this option, the gas supply systems can be connected to common gas bottles
- Bottle connection with:
  - Pressure reducer
  - Pressure gauge for inlet pressure
  - Pressure gauge for outlet pressure

Article no.	Type of gas	Gas- cylinder thread
6000085489	Argon	W21,8x1/14" (EU)
6000085490	Nitrogen	W24.32x1/14"RH (EU)
6000085491	Forming gas (95/5 and 98/2)	W21,8x1/14"LH(EU)
6000085492	Argon	W21.8x1/14"R (ES, FR, PT)
6000085493	Nitrogen	W21.8x1/14"R (ES, FR, PT)
6000085494	Forming gas (95/5 and 98/2)	W21.8L (ES, FR, PT)

## Vacuum Pump



Vacuum pump

Oil sealed rotary vane vacuum pump for universal use within the low vacuum range. Highly compact and low noise construction. Manometer included in delivery.

- Sliding vane rotary pump with sucking capacity of max. 16 m<sup>3</sup>/h
- 0,5 mbar absolute
- Connection hose made of stainless steel 2000 mm
- Connector KF16
- Manometer (-1/0.6 bar)

Article no.	Outer dimensions in mm			Connections on suction side		Connected load	Supply voltage*	Nominal suction power m <sup>3</sup> h	Suction capacity m <sup>3</sup> h-l
	W	D	H	3/4"	1/2" inner thread				
601403057	280	315	200	3/4"	1/2" inner thread	0.55 kW	230 V	16	15

\*Article no. for other possible supply voltages on request

## Cooling Platforms for Models N 17/HR, N 61/H, N 161



Storage platforms are used for forced cooling of mechanical components or annealing boxes outside of the furnace. The platform can also be used for charging the box in front of the furnace.

- Fan with 25 m<sup>3</sup>/min ambient air

Article no.	Furnace	Outer dimensions in mm			Connected load kW	Supply voltage*	Comments
		W	D	H			
631000429	up to N 17/HR	550	610	760	0.2	230 V	The same as forced cooling system MHS 17
631000529	up to N 61/H	335	1100	880 - 920	0.2	230 V	The same as CWK1 charging trolley see page 62
631000294	up to N 161	700	800	900	0.9	230 V	

\*Article no. for other possible supply voltages on request

## Charging Devices with and without Cooling Fan for Models N 31/H - N 641/13, N 30/45 HA - N 500/85 HA, LH (LF) 15/.. - LH (LF) 216/..

### Charging Cart CW(K) 1, CW(K) 15 and CW(K) 16



Charging cart CWK1

For charging larger workpieces and annealing boxes.

- 4 casters, freely movable
- Equipped with a rack at working height for temporary storage
- Fixing lock for annealing bags (CWK)
- CWK version with cooling fan (0.2 kW, 230 V)

Article no.	Designation	Furnace	Outer dimensions in mm		
			W	D	H
631000528	CW 1	N 31/H, N 41..., N 61..., N 30/..HA, N 60/..HA	330	1100	880 - 920
631001320	CW 15	LH(LF) 15/.. - LH(LF) 60/..	370	1100	760 - 800
631001321	CW 16	LH(LF) 120/.. - LH(LF) 216/..	470	1000	760 - 800
631000529	CWK 1	N 31/H, N 41..., N 61..., N 30/..HA, N 60/..HA	330	1100	880 - 920
631001322	CWK 15	LH(LF) 15/.. - LH(LF) 60/..	370 + 100 <sup>1</sup>	1100	760 - 800
631001323	CWK 16	LH(LF) 120/.. - LH(LF) 216/..	470 + 80 <sup>1</sup>	1100	760 - 800

Art.-No. for NA 30/.. and NA 60/.. on request

<sup>1</sup> Side switch

### Charging Cart CW 2 - CW 4 and CWK 2 - CWK 4



Charging cart CW 2

For charging larger workpieces and annealing boxes.

- 2 casters, 2 fixed rollers for heavy loads
- Equipped with a grid at working height for temporary storage
- Furnace locking via pedal lever
- CWK version with cooling fan (0,9 kW, 230 V)

Article no.	Designation	Furnace	Outer dimensions in mm		
			W	D	H
631000530	CW 2	N 81..., N 161..., N 120/..HA	500	1120	880 - 920
631000531	CW 3	N 321..	800	1490	880 - 920 <sup>2</sup>
631000468	CW 4	N 641..	1040	1950	880 - 920 <sup>2</sup>
631000469	CWK 2	N 81..., N 161..., N 120/..HA	500 + 80 <sup>1</sup>	1120	880 - 920
631000470	CWK 3	N 321..	800 + 80 <sup>1</sup>	1490	880 - 920 <sup>2</sup>
631000471	CWK 4	N 641..	1040 + 80 <sup>1</sup>	1950	880 - 920 <sup>2</sup>

Art.-No. for NA 120/.. on request

\*Please see page 80 for more information about supply voltage

<sup>1</sup> Side switch

<sup>2</sup> Without holding grip



Charging Stacker WS 1

### Charging Cart WS 1

For charging of protective gas and annealing boxes.

- 2 casters, 2 fixed rollers for heavy loads
- With parallel guided lifting mechanism
- Only for boxes with preparation for charging device (standard since 07.2018)
- Will be delivered with drive-in aid for the relevant furnace model
- Guiding track and charging cart can be also ordered separately

Article no.	Designation	Furnace
6000004965	WS 1	N 61/H, N 81, N 60/..HA, N 120/..HA, NA 60/.., NA 120/.., LH 60/.., LH 120/..

Article no. guiding track	Furnace
6000006118	NA 60/..
6000006101	NA 120/..
6000005811	LH 60/..
6000005372	LH 120/..
6000006155	N 61/H
on request	N 81
on request	N 60/..HA
on request	N 120/..HA



WS 50 charging stacker

### Charging Stacker WS 25 - WS 321

- Lifting device with hand winch
- Compact construction with push bar and manual lifting device for easy and safe lifting
- 2 casters, 2 fixed rollers
- Adjustable loading fork width
- Max. charging weight 500 kg
- Guiding track, mounted at the furnace base frame
- Guiding track and forklift can be also ordered separately



Guiding track at the base frame

Article no.	Designation	Furnace
631000425	WS 161	N 161..
631000370	WS 321	N 321..
631000299	WS 25	N 250/..HA
631000532	WS 50	N 500/..HA

Art.-No. for NA 250/.. and NA 500/.. on request

### WS 641 Charging Stacker

Design as charging stacker WS 25 - WS 321, but

- Lifting device with manual hydraulic
- Max. charging weight 700 kg



Charging stacker WS 641 with chamber furnace N 641 and guiding track at the base frame

Article no.	Designation	Furnace
631000426	WS 641	N 641..

# Furnaces for Debinding and Sintering up to 1800 °C

Furnaces for debinding up to 600 °C and subsequent sintering 1800 °C under air, for example of ceramic components.



Dual shell housing made of textured stainless steel sheets with additional fan cooling for low surface temperature



Stainless steel exhaust hood as interface to customer's exhaust system for all standing models



Exclusive use of insulation materials without categorization according to EC Regulation No 1272/2008 (CLP). This explicitly means that alumino silicate wool, also known as "refractory ceramic fiber" (RCF), which is classified and possibly carcinogenic, is not used.



NTLog Basic for Nabertherm controller: recording of process data with USB-flash drive



Defined application within the constraints of the operating instructions



As additional equipment: Process control and documentation via VCD software package for monitoring, documentation and control





Furnace Group	Model	Page
Ashing furnaces with integrated exhaust gas cleaning	L ../11 BO	66
High-temperature furnaces with MoSi <sub>2</sub> heating elements up to 1800 °C	LHT ..	68

# Ashing Furnaces L ../11 BO up to 1100 °C with Integrated Catalytic Post Combustion

The ashing furnaces L ../11 BO are specially designed for processes in which organic substances have to be evaporated from the charge, as e. g. during debinding of small ceramic products after additive manufacturing. Other processes, for which this furnace series is designed for, are for example, ashing of (food) samples, thermal cleaning of injection molding tools or loss on ignition determination.

The ashing furnaces therefore have a passive safety system and integrated exhaust gas post combustion. An exhaust gas fan extracts the exhaust gases from the furnace and simultaneously supplies fresh air to the furnace atmosphere with the result that sufficient oxygen is always available for the process. The incoming air is guided behind the furnace heating and preheated to ensure good temperature uniformity. Exhaust gases are directly led from the furnace chamber to the integrated post combustion system, where they are burned and catalytically cleaned. After the debinding/ashing process (up to max. 600 °C), a sintering process up to max. 1100 °C can be performed.



Ashing furnace L 40/11 BO

## Standard Equipment

- Tmax 600 °C for the incineration process
- Tmax 1100 °C for the subsequent process
- Three-side heating (both sides and bottom)
- Ceramic heating plates with embedded heating wire
- Steel collecting pan protects the bottom insulation
- Spring-assisted closing of the furnace door (flap door) with mechanical locking against unintentional opening
- Thermal/catalytic post combustion, integrated in the exhaust channel, up to 600 °C in function
- Temperature control of post combustion can be set up to 850 °C
- Monitored exhaust air
- Inlet-air preheated through the bottom heating plate
- Controller with touch operation C550 (10 programs with each 20 segments), alternative controllers see page 80

Model	Tmax in °C <sup>1</sup>	Inner dimensions in mm			Volume in l	Outer dimensions <sup>2</sup> in mm			Max. weight of hydrocarbons in g	Max. evaporation rate g/min	Connected load in kW	Electrical connection*	Weight in kg
		w	d	h		W	D	H <sup>3</sup>					
L 9/11 BO	1100	230	240	170	9	415	575	750	75	1.0	7.0	3-phase	60
L 24/11 BO	1100	280	340	250	24	490	675	800	150	2.0	9.0	3-phase	90
L 40/11 BO	1100	320	490	250	40	530	825	800	200	2.1	11.5	3-phase	110

<sup>1</sup>Recommended working temperature for processes with longer dwell times is 1000 °C

<sup>2</sup>External dimensions vary when furnace is equipped with additional equipment. Dimensions on request.

<sup>3</sup>Including exhaust tube (Ø 80 mm)

\*Please see page 80 for more information about supply voltage



Ashing furnace L 9/11 BO



Steel collecting pan protects the bottom insulation



■ Hot air  
■ Cold air

Schematic presentation of air circulation in ashing furnace L 24/11 BO

## High-Temperature Furnaces with MoSi<sub>2</sub> Heating Elements up to 1800 °C

Designed as tabletop models, these compact high-temperature furnaces have a variety of advantages. The first-class workmanship using high-quality materials, combined with ease of operation, make these furnaces all-rounders in research and the laboratory. These high-temperature furnaces are also perfectly suited for the sintering of technical ceramics, such as zirconium oxide dental bridges.



High-temperature furnace LHT 01/17 D

### Standard Equipment

- Tmax 1600 °C, 1750 °C, or 1800 °C
- Recommended working temperature 1750 °C (for models LHT ../18), increased wear and tear must be expected in case of working at higher temperatures
- High-quality molybdenum disilicide heating elements
- Adjustable air inlet opening, exhaust air opening in the roof
- Type B thermocouple
- Controller P570 (50 programs with each 40 segments), controls description see page 76

### Additional Equipment

- Over-temperature limiter with adjustable cutout temperature as temperature limiter to protect the furnace and load
- Protective gas connection to purge with non-flammable protective or reaction gases, not gas tight
- Manual or automatic gas supply system

Model	Tmax in °C	Inner dimensions in mm			Volume in l	Outer dimensions <sup>1</sup> in mm			Connected load in kW	Electrical connection*	Weight in kg	Heating time in min <sup>3</sup>
		w	d	h		W	D	H <sup>2</sup>				
LHT 02/16	1600	90	150	150	2	470	630	760+260	3.0	1-phase	75	30
LHT 04/16	1600	150	150	150	4	470	630	760+260	5.2	3-phase <sup>4</sup>	85	25
LHT 08/16	1600	150	300	150	8	470	810	760+260	8.0	3-phase <sup>4</sup>	100	25
LHT 01/17 D	1650	110	120	120	1	385	425	525+195	2.9	1-phase	28	35
LHT 03/17 D	1650	135	155	200	4	470	630	770+260	3.0	1-phase	75	30
LHT 02/17	1750	90	150	150	2	470	630	760+260	3.0	1-phase	75	35
LHT 04/17	1750	150	150	150	4	470	630	760+260	5.2	3-phase <sup>4</sup>	85	30
LHT 08/17	1750	150	300	150	8	470	810	760+260	8.0	3-phase <sup>4</sup>	100	30
LHT 02/18	1800	90	150	150	2	470	630	760+260	3.6	1-phase	75	60
LHT 04/18	1800	150	150	150	4	470	630	760+260	5.2	3-phase <sup>4</sup>	85	40
LHT 08/18	1800	150	300	150	8	470	810	760+260	9.0	3-phase <sup>4</sup>	100	40

<sup>1</sup>External dimensions vary when furnace is equipped with additional equipment. Dimensions on request.

<sup>2</sup>Including opened lift door

<sup>3</sup>Heating time of the empty and closed furnace up to Tmax - 100 K (connected to 230 V 1/N/PE resp. 400 V 3/N/PE)

\*Please see page 80 for more information about supply voltage

<sup>4</sup>Heating only between two phases



High-temperature furnace LHT 01/17 D



Saggars with top lid



Example of an over-temperature limiter

# High-Temperature Furnaces with Molybdenum Disilicide Heating Elements with Fiber Insulation up to 1800 °C

Thanks to the sturdy design, the high-temperature furnaces fulfill the demands of everyday use in laboratories and production. The compact standard models are particularly suitable for the production of technical ceramics such as bio ceramics or the sintering of CIM components where high working temperatures are needed and high-quality standards are required. The very good temperature uniformity and useful options set high-quality benchmarks and are the optimum solution for many applications. The furnaces can be extended with extra features from our extensive range to suit specific processes.



High-temperature furnace HT 29/17

## Standard Equipment

- Tmax 1600 °C, 1750 °C, or 1800 °C
- Recommended maximum working temperature approx. 50 °C below Tmax of the furnace. Higher working temperatures will increase wear and tear.
- Heating from both sides via molybdenum disilicide heating elements
- High-quality fiber insulation backed by special insulation
- Long-life roof insulation with special suspension
- Temperature uniformity at 1450 °C up to  $\pm 6$  °C according to DIN 17052-1 see page 72
- Chain-guided parallel swivel door for precise opening and closing of the door
- Two-door design (front/back) for high-temperature furnaces from HT 276/..
- Labyrinth sealing ensures the least possible temperature loss in the door area
- Reinforced floor as protection for bottom insulation as standard from models HT 16/16 upwards (distributed load 5 kg/dm<sup>2</sup>)
- Vapor vent in the furnace roof with motorized exhaust air flap, controlled via the extra function of the controller
- Stainless steel exhaust hood as interface to customer's exhaust system
- Controller with touch operation P570 (50 programs with each 40 segments), controls description see page 80



High temperature chamber furnace HT 450/16 with two locking devices per door

## Additional Equipment

- Cooling system to cool the furnace with a defined temperature gradient or with a preset fresh air volume. Both operating modes can be switched on and off for different segments by means of the extra function of the controller.
- Thermocouple inlet with screw cap
- Thermocouple for the heating control with calibration certificate
- Protective gas connection to purge with non-flammable process gases (not completely gas-tight)
- Automatic gas supply system with solenoid valve and rotameter, controlled by the extra function of the controller
- Refractory brick floor insulation for a higher floor load (Tmax 1700 °C)
- Lift door
- Automatic door lock incl. door contact switch
- Heating elements protected against mechanical damage
- Special heating element qualities e. g. for zircon oxide applications
- Ethernet interface



High-temperature furnace HT 160/17 with gas supply system



High-temperature furnace HT 64/17 with PLC controls and additional options

Model	Tmax °C	Inner dimensions in mm			Volume in l	Outer dimensions <sup>1</sup> in mm			Connected load in kW	Electrical connection*	Weight in kg
		w	d	h		W	D	H			
HT 08/16	1600	150	300	150	8	740	640	1755	8.5	3-phase <sup>2</sup>	215
HT 16/16	1600	200	300	260	16	820	690	1860	12.5	3-phase <sup>2</sup>	300
HT 29/16	1600	275	300	350	29	985	740	1990	9.8	3-phase <sup>2</sup>	350
HT 40/16	1600	300	350	350	40	1010	800	1990	12.5	3-phase	420
HT 64/16	1600	400	400	400	64	1140	890	2040	18.5	3-phase	555
HT 128/16	1600	400	800	400	128	1140	1280	2040	26.5	3-phase	820
HT 160/16	1600	500	550	550	160	1250	1040	2260	21.5	3-phase	760
HT 276/16	1600	500	1000	550	276	1340	1600	2290	43.5	3-phase	1270
HT 450/16	1600	500	1150	780	450	1380	1820	2570	65.0	3-phase	1570
HT 08/17	1750	150	300	150	8	740	640	1755	8.5	3-phase <sup>2</sup>	215
HT 16/17	1750	200	300	260	16	820	690	1860	12.5	3-phase <sup>2</sup>	300
HT 29/17	1750	275	300	350	29	985	740	1990	9.8	3-phase <sup>2</sup>	350
HT 40/17	1750	300	350	350	40	1010	800	1990	12.5	3-phase	420
HT 64/17	1750	400	400	400	64	1140	890	2040	18.5	3-phase	555
HT 128/17	1750	400	800	400	128	1140	1280	2040	26.5	3-phase	820
HT 160/17	1750	500	550	550	160	1250	1040	2260	21.5	3-phase	760
HT 276/17	1750	500	1000	550	276	1340	1600	2290	43.5	3-phase	1270
HT 450/17	1750	500	1150	780	450	1380	1820	2570	65.0	3-phase	1570
HT 08/18	1800	150	300	150	8	740	640	1755	8.5	3-phase <sup>2</sup>	215
HT 16/18	1800	200	300	260	16	820	690	1860	12.5	3-phase <sup>2</sup>	300
HT 29/18	1800	275	300	350	29	985	740	1990	9.8	3-phase <sup>2</sup>	350
HT 40/18	1800	300	350	350	40	1010	800	1990	12.5	3-phase	420
HT 64/18	1800	400	400	400	64	1140	890	2040	18.5	3-phase	555
HT 128/18	1800	400	800	400	128	1140	1280	2040	26.5	3-phase	820
HT 160/18	1800	500	550	550	160	1250	1040	2260	21.5	3-phase	760
HT 276/18	1800	500	1000	550	276	1340	1600	2290	43.5	3-phase	1270
HT 450/18	1800	500	1150	780	450	1380	1820	2570	65.0	3-phase	1570

<sup>1</sup>External dimensions vary when furnace is equipped with additional equipment. Dimensions on request.  
<sup>2</sup>Heating only between two phases

\*Please see page 80 for more information about supply voltage



Automatic gas supply system with solenoid valve and rotameter



Two-door design for high-temperature furnaces > HT 276/..



High-temperature furnace HT 160/18 DB200-3 with lift door

# Process Control and Documentation

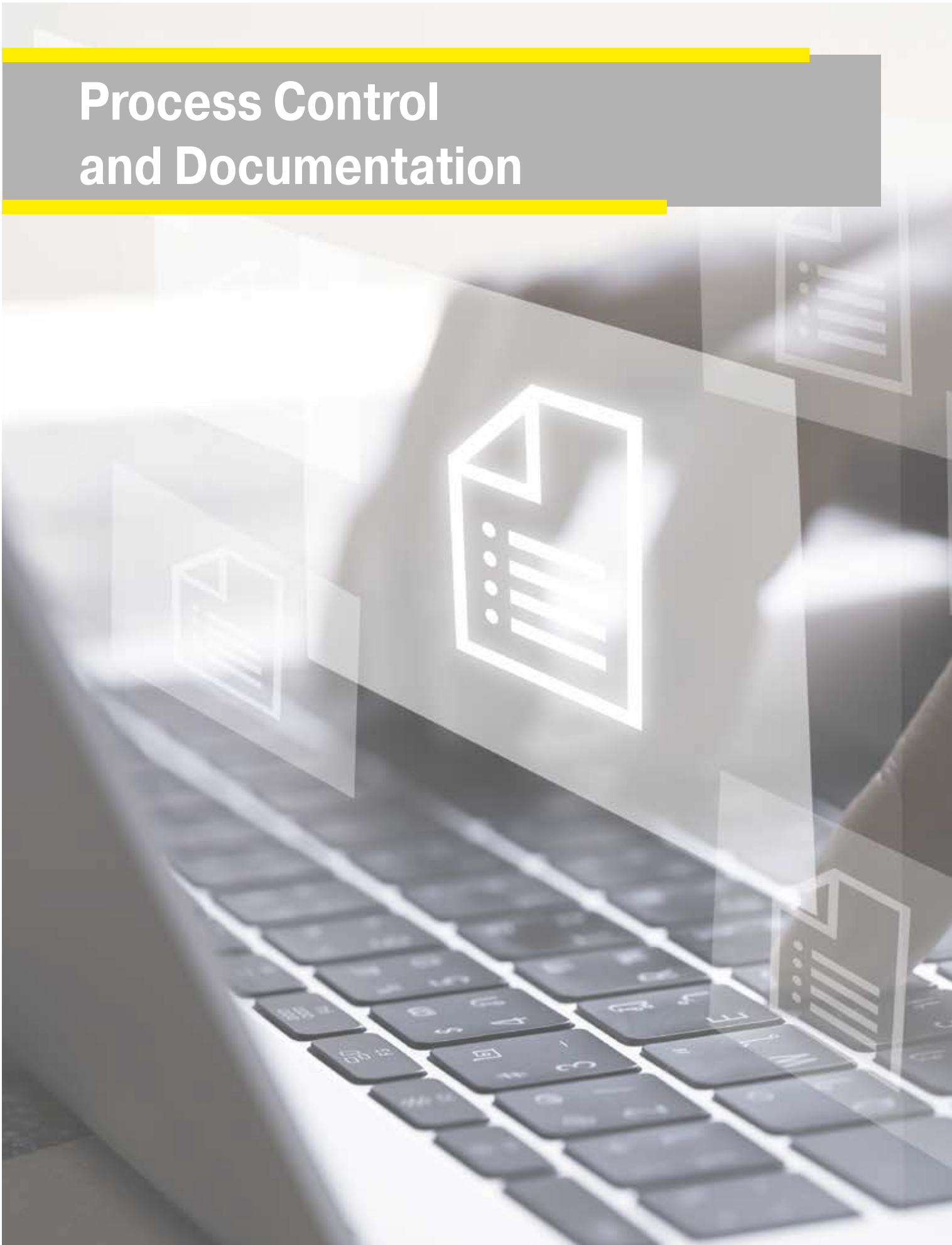



	Page
Temperature uniformity and system accuracy	72
AMS2750F, NADCAP, CQI-9	73
Nabertherm controller series 500	76
MyNabertherm app	78
Functions of the standard controllers	80
Process data storage and data input via PC	81
PLC controls	83
Process data storage	84
Nabertherm control center NCC	85

# Temperature Uniformity and System Accuracy

Temperature uniformity is defined as the maximum temperature deviation in the work space of the furnace. There is a general difference between the furnace chamber and the work space. The furnace chamber is the total volume available in the furnace. The work space is smaller than the furnace chamber and describes the volume which can be used for charging.



Holding frame for measurement of temperature uniformity

## Specification of Temperature Uniformity in +/- K in the Standard Furnace

In the standard design the temperature uniformity is specified in +/- K at a defined set-temperature with the work space of the empty furnace during the dwell time. In order to make a temperature uniformity survey the furnace should be calibrated accordingly. As standard our furnaces are not calibrated upon delivery.

## Calibration of the Temperature Uniformity in +/- K

If an absolute temperature uniformity at a reference temperature or at a defined reference temperature range is required, the furnace must be calibrated appropriately. If, for example, a temperature uniformity of +/- 5 K at a set temperature of 750 °C is required, it means that measured temperatures may range from a minimum of 745 °C to a maximum of 755 °C in the empty work space.

## System Accuracy

Tolerances may occur not only in the work space, they also exist with respect to the thermocouple and in the controls. If an absolute temperature uniformity in +/- K at a defined set temperature or within a defined reference working temperature range is required, the following measures have to be taken:

- Measurement of total temperature deviation of the measurement line from the controls to the thermocouple
- Measurement of temperature uniformity within the work space at the reference temperature or within the reference temperature range
- If necessary, an offset is set at the controls to adjust the displayed temperature at the controller to the real temperature in the furnace
- Documentation of the measurement results in a protocol

## Temperature Uniformity in the Work Space incl. Protocol

In standard furnaces, temperature uniformity is guaranteed as +/- K without measurement of temperature uniformity. However, as an additional feature, a temperature uniformity measurement at a target temperature in the work space compliant with DIN 17052-1 can be ordered. Depending on the furnace model, a holding frame which is equivalent in size to the work space is inserted into the furnace. This frame holds thermocouples at up to 11 defined measurement positions. The measurement of the temperature uniformity is performed at a target temperature specified by the customer after a static condition has been reached. If necessary, different target temperatures or a defined target working temperature range can also be calibrated.



Pluggable frame for measurement for forced convection chamber furnace N 7920/45 HAS

The system accuracy is defined by adding the tolerances of the controls, the thermocouple and the work space



Precision of the controls, e. g. +/- 1 K

Deviation of thermocouple, e. g. +/- 1.5 K

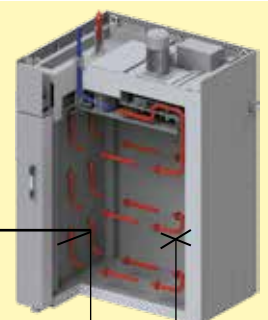

Deviation from measuring point to the average temperature in the work space e. g. +/- 3 K



# AMS2750F, NADCAP, CQI-9

Standards such as the AMS2750F (Aerospace Material Specifications) are applicable for the industrial processing of high-quality materials. They define industry-specific requirements for heat treatment. Today, the AMS2750F and derivative standards such as AMS2770 for the heat treatment of aluminum are the guidelines for the aerospace industry. After the introduction of the CQI-9, the automotive industry has also committed to submit heat treatment processes to stricter rules. These standards describe in detail the requirements applicable to thermal processing plants.

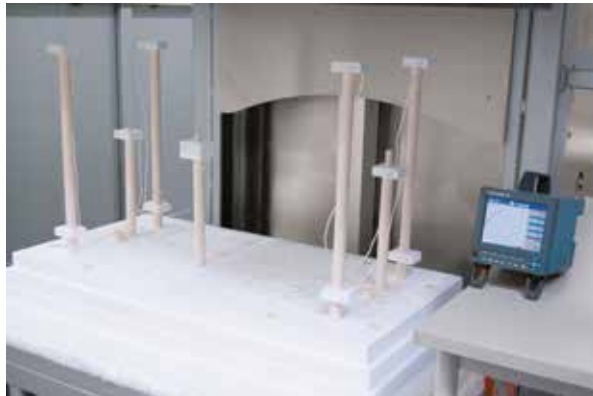

Measurement set-up in a high-temperature furnace

- Temperature uniformity in the work space (TUS)
- Instrumentation (definition of measurement and control systems)
- Calibration of the measurement system (IT) from the controller via the measurement line to the thermocouple
- Inspections of system accuracy (SAT)
- Documentation of the inspection cycles

Norm compliance is necessary to ensure that the required quality standard of the manufactured components can also be reproduced in series. For this reason, extensive and repeated inspections as well as controls of the instrumentation, including the relevant documentation, are required.

## Furnace Class and Instrumentation Requirements of the AMS2750F

Depending on the quality requirements of heat treatment job the customer specifies instrumentation type and the temperature uniformity class. The instrumentation type describes the necessary combination of the applied control, recording media as well as thermocouples. The temperature uniformity of the furnace and the class of the selected instrumentation are defined based on the required furnace class. The higher the requirements are set for the furnace class the more precise the instrumentation must be.

## Regular Inspections

The furnace or the heat treatment plant must be designed so that the requirements of the AMS2750F can be met and be reproduced. The standard also requires the inspection intervals for the instrumentation (SAT = System Accuracy Test) and the temperature uniformity of the furnace (TUS = Temperature Uniformity Survey). The SAT/TUS tests must be performed by the customer with measuring devices and sensors which operate independently of the furnace instrumentation.

Instrumentation	Type						Furnace class	Temperature uniformity	
	A	B	C	D+	D	E		°C	°F
Each control zone has a thermocouple connected to the controller	x	x	x	x	x	x	1	+/- 3	+/- 5
Recording of the temperature measured by the control thermocouple	x	x	x	x	x		2	+/- 6	+/- 10
Sensors for recording the coldest and hottest spots			x				3	+/- 8	+/- 15
Each control zone has a charge thermocouple with recording system	x	x					4	+/- 10	+/- 20
One additional recording sensor, distance ≥ 76 mm to control sensor, of a different sensor type				x			5	+/- 14	+/- 25
Each control zone has an over-temperature protection unit	x	x	x	x	x		6	+/- 28	+/- 50



Measurement set-up in an annealing furnace



Measuring protocol

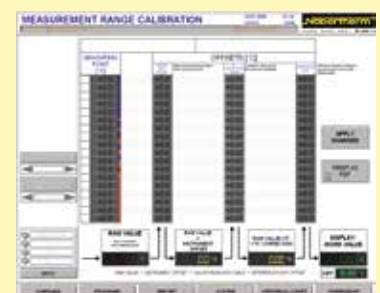

Measurement range calibration

# AMS2750F, NADCAP, CQI-9

The suitable furnace model for the corresponding heat treatment can be designed based on the process, the charge, the required furnace class and the type of instrumentation. Depending on the required specs, alternative solutions can be offered.



N 12012/26 HAS1 according to AMS2750F

- Furnace designs, which meet standards, following customer specifications regarding furnace class and instrumentation, incl. gauge connections for repeated customer inspections at regular intervals. No consideration of requirements with respect to documentation
- Data recording devices (e.g., temperature recorder) for TUS and/or SAT measurements see page 84
- Data recording, visualization, time management via the Nabertherm Control Center (NCC), based on Siemens WinCC software see page 85
- Commissioning at site, incl. the first TUS and SAT inspection
- Connection of existing furnace plant to meet norm requirements
- Documentation of the complete process chain in line with the corresponding norm

## Implementation of AMS2750F

Basically, two different systems are available for control and documentation, a proven Nabertherm system solution or instrumentation using Eurotherm controllers/temperature recorders. The Nabertherm AMS package is a convenient solution that includes the Nabertherm Control Center for control, visualization, and documentation of the processes and test requirements based on PLC controls.

## Instrumentation with Nabertherm Control Center (NCC)

The attractive feature of the instrumentation with Nabertherm Control Center in combination with PLC controls of the furnace is the convenient data input and visualization. The software programming is structured in a way that both the user and the auditor can navigate it without difficulty.



In daily use, the following product characteristics stand out:

- Very easy to navigate and straight-forward presentation of all the data in plain text on the PC
- Automatic saving of the charge documentation at the end of the program
- Administration of the calibration cycles in the NCC
- Results of the measurement distance calibration are entered in the NCC
- Schedule management of the required testing cycles including a reminder function. The testing cycles for TUS (Temperature Uniformity Survey) and SAT (System Accuracy Test) are entered in days and monitored by the system and the operator or tester is informed in time about up-coming tests. The measurements have to be done with separate calibrated measuring equipment.
- Option of transferring the measurement data to a customer's server

The Nabertherm Control Center can be extended to enable a complete documentation of the heat treatment process apart from just the furnace data. For example, when heat-treating aluminum, in addition to the furnace, the temperatures in the quenching basin or a separate cooling medium can also be documented.

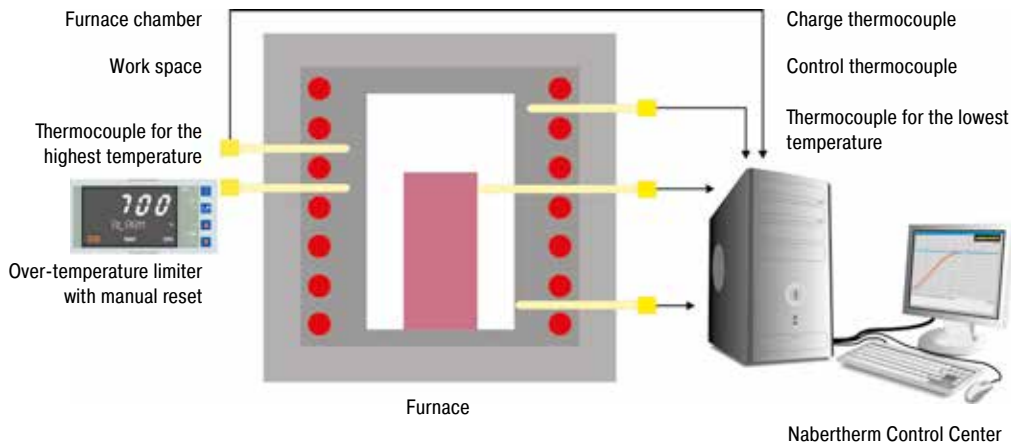

Example of a design with Type A Nabertherm Control Center

## Alternative Instrumentation with Temperature Controllers and Recorders from Eurotherm

As an alternative to instrumentation with the Nabertherm Control Center (NCC) and PLC controls, instrumentation with controllers and temperature recorders is also available. The temperature recorder has a log function that must be configured manually. The data can be saved to a USB stick and be evaluated, formatted, and printed on a separate PC. Besides the temperature recorder, which is integrated into the standard instrumentation, a separate recorder for the TUS measurements is needed (see page 84).

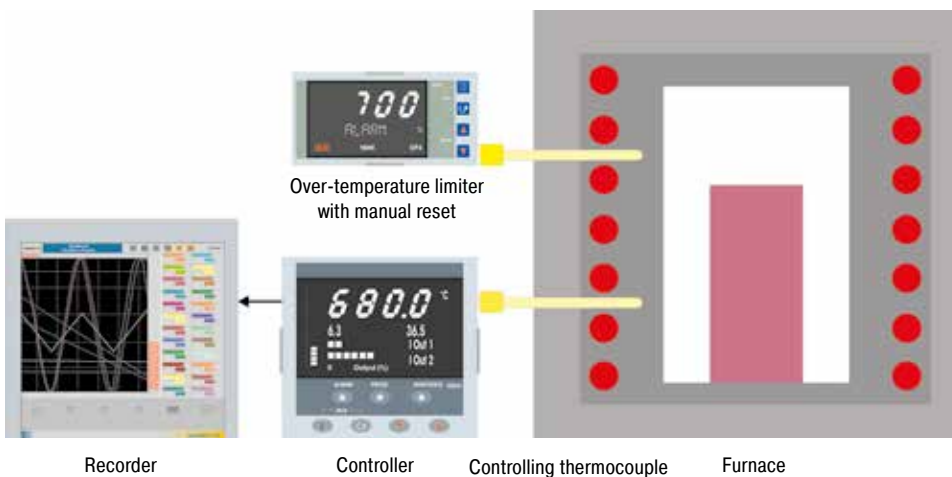

Example of a design containing Type D Eurotherm instrumentation

## Furnace Chamber Control

Only the furnace chamber temperature is measured and controlled. Regulation is carried out slowly to avoid out-of-range values. As the charge temperature is not measured and controlled, it may vary a few degrees from the chamber temperature.

## Charge Control

If the charge control is switched on, both the charge temperature and furnace chamber temperature are measured. By setting different parameters the heat-up and cooling processes can be individually adapted. This results in a more precise temperature control at the charge.

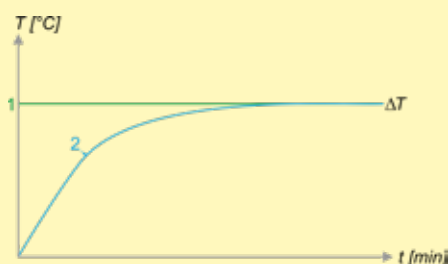

Furnace control

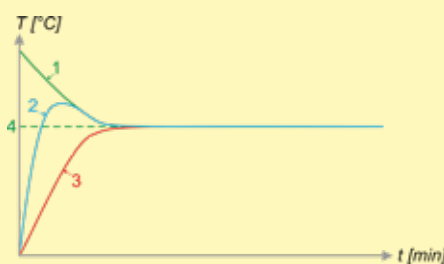

Charge control

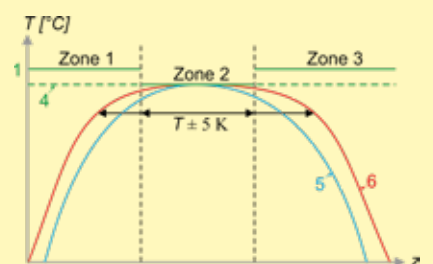

Three-zone furnace chamber control using the example of a tube furnace

1. Set value furnace chamber - 2. Actual value furnace chamber - 3. Actual value charge - 4. Set value charge - 5. Actual value furnace chamber single zone - 6. Actual value furnace chamber three zone

## Nabertherm Controller Series 500

**I AM THE  
CONTROLLER**

I'm the big brother of analog buttons and turning switches. I am the new generation of control and intuitive operation. My skills are highly complex, my operation is simple. I can be touched and speak 24 languages. I'll show you exactly which program is currently running and when it ends.



The controller series 500 impresses with its unique scope of performance and intuitive operation. In combination with the free "MyNabertherm" smartphone app, the operation and monitoring of the furnace is even easier and more powerful than ever before. The operation and programming takes place via a high-contrast, large touch panel, which shows exactly the information that is relevant at the moment.



B510, C550, P580



B500, C540, P570

### Standard Equipment

- Transparent, graphic display of the temperature curves
- Clear presentation of the process data
- 24 operating languages selectable
- Consistent, attractive design
- Easily understandable symbols for many functions
- Precise and accurate temperature control
- User levels
- Program status display with estimated end time and date
- Documentation of the process curves on USB storage medium in .csv file format
- Service information can be read out via USB stick
- Clear presentation
- Plain text display
- Configurable for all furnace families
- Can be parameterized for the different processes



## Highlights

In addition to the well-known and matured controller functions, the new generation offers you some individual highlights. Here is an overview of the most important ones for you:

### Modern Design

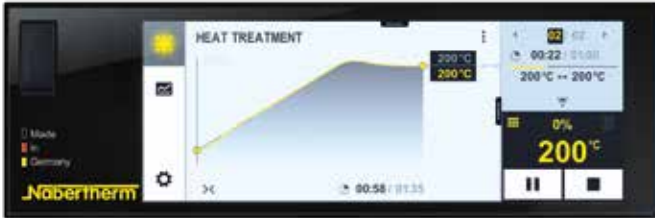

Colored display of temperature curves and process data

### Easy Programming



Simple and intuitive program entry via touch panel

### Integrated Help Function



Information on various commands in plain text

### Program Management



Temperature programs can be saved as favorites and in categories

### Segment Player



Detailed overview of process information including setpoint, actual value and switched functions

### Wi-Fi-Capable



Connection with the MyNabertherm app



Intuitive touch screen



Easy program entry and control



Precise temperature control



User levels



Process documentation on USB

Further information on Nabertherm controllers, process documentation and tutorials on operation can be found on our website: <https://nabertherm.com/en/series-500>



# MyNabertherm App for Mobile Monitoring of Process Progress

MyNabertherm app – the powerful and free digital accessory for Nabertherm 500 Series Controllers. Use the app for convenient online progress monitoring of your Nabertherm furnaces – from your office, while on the way or from wherever you wish. The app always keeps you in the picture. Just like the controller itself, the app is also available in 24 languages.



Convenient monitoring of one or multiple Nabertherm furnaces simultaneously



Display of program progress for each furnace



Easy to contact

## App-Functions

- Convenient monitoring of one or multiple Nabertherm furnaces simultaneously
- Clear presentation as a dashboard
- Individual overview of a furnace
- Display of active/inactive furnaces
- Operating status
- Current process data

## Display of Program Progress for Each Furnace

- Graphical representation of the program progress
- Display of furnace name, program name, segment information
- Display of start time, program run time, remaining run time
- Display of additional functions such as fresh-air fan, exhaust air flap, gassing, etc.
- Operating modes as symbol

## Push Notifications in Case of Malfunctions and at Program End

- Push notification on the lock screen
- Display of malfunctions with an associated description in the individual overview and in a message list

## Contact with Service Possible

- Stored furnace data facilitate rapid support for you

## Requirements

- Connection of the furnace to the Internet via the customer's Wi-Fi
- For mobile devices with Android (from version 9) or IOS (from version 13)



Monitoring of Nabertherm furnaces with 500 series touch panel controller for Arts & Crafts, laboratory, dental, thermal process technology, advanced materials and foundry applications.

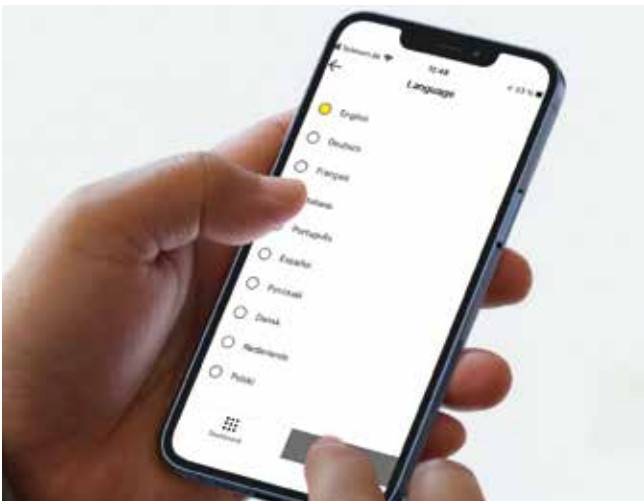

Available in 24 languages



Push notifications in case of malfunctions



Clear contextual menu



Any addition of Nabertherm furnaces

Everything on display in the new Nabertherm app for the new controller series 500. Get the most out of your furnace with our app for iOS and Android. Don't hesitate to download it now.



# Functions of the Standard Controllers

	R7	3216	3208	B500/ B510	C540/ C550	P570/ P580	3508	3504	H500	H1700	H3700	NCC
Number of programs	1	1		5	10	50	1/10/ 25/50 <sup>3</sup>	1/10/ 25/50 <sup>3</sup>	20	20	20	100
Segments	1	8		4	20	40	500 <sup>3</sup>	500 <sup>3</sup>	20	20	20	20
Extra functions (e. g. fan or autom. flaps) maximum				2	2	2-6	0-4 <sup>3</sup>	2-8 <sup>3</sup>	3 <sup>3</sup>	6/2 <sup>3</sup>	8/2 <sup>3</sup>	16/4 <sup>3</sup>
Maximum number of control zones	1	1	1	1	1	3	2 <sup>1,2</sup>	2 <sup>1,2</sup>	1-3 <sup>3</sup>	8	8	8
Drive of manual zone regulation				●	●	●						
Charge control/bath control						●	○	○	○	○	○	○
Auto tune		●	●	●	●	●	●	●				
Real-time clock				●	●	●			●	●	●	●
Graphic color display				●	●	●			4" 7"	7"	12"	22"
Graphic display of temperature curves (program sequence)												
Status messages in clear text			●	●	●	●	●	●	●	●	●	●
Data entry via touchpanel				●	●	●			●	●	●	
Entering program names (i.e. "Sintering")				●	●	●			●	●	●	●
Keypad lock				●	●	●	○	○				
User levels				●	●	●	●	●	○	○	○	●
Skip-button for segment jump				●	●	●			●	●	●	●
Program entry in steps of 1 °C or 1 min.	●	●	●	●	●	●	●	●	●	●	●	●
Start time configurable (e. g. to use night power rates)				●	●	●	●	●	●	●	●	●
Switch-over °C/°F	○	○	○	●	●	●	○	○	●	● <sup>3</sup>	● <sup>3</sup>	● <sup>3</sup>
kWh meter				●	●	●						
Operating hour counter				●	●	●			●	●	●	●
Set point output			○	●	●	●	○	○		○	○	○
NTLog Comfort for HiProSystems: recording of process data on an external storage medium									○	○	○	
NTLog Basic for Nabertherm controller: recording of process data with USB-flash drive				●	●	●						
Interface for VCD software				○	○	○	○	○				
Malfunction memory				●	●	●			●	●	●	●
Number of selectable languages				24	24	24						
Wi-Fi-capable („MyNabertherm" app)				●	●	●						

<sup>1</sup> Not for melt bath control

<sup>2</sup> Control of additional separate slave regulators possible

<sup>3</sup> Depending on the design

● Standard

○ Option

## Assignment of Standard Controllers to Furnace Families

	NR(A) 20/06 - NR(A) 1000/11	NR, NRA .. H <sub>2</sub>	NR, NRA .. IDB	NR, NRA 40/02 CDB	NR, NRA 150/02 CDB	VHT	VHT .. H <sub>2</sub>	NA 120/45 - N 675/85	NAT	TR	KTR	LH 15/12 - LF 120/14	NW	N 7/H - N 87/H	N 81(/..) - N 641(/..)	L ../11 BO	LHT	HT
Catalog page	18	20	20	22	22	24	28	32	38	40	42	46	50	52	52	66	67	68
Controller																		
C6/3208								○			○				○			
3504	○							○		○	○				○			
R 7										●								
B500								●	●		●	●	●	●	●			
B510									●	○								
C540								○		○	○	○	○	○	○			
C550									○	○	○	○	○	○	○	●		
P570	●					● <sup>3</sup>		○	○	○	○	○	○	○	○	○	●	● <sup>3</sup>
P580									○	○		○	○	○		○		
H500/PLC								○				○		○	○			● <sup>3</sup>
H700/PLC						● <sup>3</sup>												○
H1700/PLC			●	●				○			○			○	○			○
H3700/PLC	○	●			●	○	●	○			○	○		○	○			○
NCC	○	○	○	○	○	○	○	○			○	○		○	○			○

## Mains Voltages for Nabertherm Furnaces

1-phase: all furnaces are available for mains voltages from 110 V - 240 V at 50 or 60 Hz.

3-phase: all furnaces are available for mains voltages from 200 V - 240 V or 380 V - 480 V, at 50 or 60 Hz.

The connecting rates in the catalog refer to the standard furnace with 400 V (3/N/PE) respectively 230 V (1/N/PE).



## Process Data Storage and Data Input via PC



There are various options for evaluation and data input the processes for optimal process documentation and data storage. The following options are suitable for data storage when using the standard controllers.

### Data Storing of Nabertherm Controllers with NTLog Basic

NTLog Basic allows for recording of process data of the connected Nabertherm Controller (B500, B510, C540, C550, P570, P580) on a USB stick. The process documentation with NTLog Basic requires no additional thermocouples or sensors. Only data recorded which are available in the controller. The data stored on the USB stick (up to 130,000 data records, format CSV) can afterwards be evaluated on the PC either via NTGraph or a spreadsheet software used by the customer (e.g. Excel™ for MS Windows™). For protection against accidental data manipulation the generated data records contain checksums.

### Visualization with NTGraph for MS Windows™ for Single-Zone Controlled Furnaces

The process data from NTLog can be visualized either using the customer's own spreadsheet program (e.g. Excel™ for MS Windows™) or NTGraph for MS Windows™ (Freeware). With NTGraph Nabertherm provides for an additional user-friendly tool free of charge for the visualization of the data generated by NTLog. Prerequisite for its use is the installation of the program Excel™ for MS Windows™ (from version 2003). After data import presentation as diagram, table or report can be chosen. The design (color, scaling, reference labels) can be adapted by using prepared sets. NTGraph is available in eight languages (DE/EN/FR/ES/IT/CN/RU/PT). In addition, selected texts can be generated in other languages.

### Software NTEdit for MS Windows™ for Entering Programs on the PC

By using the software NTEdit for MS Windows™ (Freeware) the input of the programs becomes clearer and thus easier. The program can be entered on customers PC and then be imported into the controller (B500, B510, C540, C550, P570, P580) with a USB stick. The display of the set curve is tabular or graphical. The program import in NTEdit is also possible. With NTEdit Nabertherm provides a user-friendly free tool. A prerequisite for the use is the client installation of Excel™ for MS Windows™ (from version 2007). NTEdit is available in eight languages (DE/EN/FR/ES/IT/CN/RU/PT).



NTGraph, a freeware for the easy-to-read analysis of recorded data using Excel™ for MS Windows™



Recording of process data of the connected controller via USB stick



Process input via the NTEdit software (freeware) for MS Windows™

# Process Data Storage

## VCD-software for visualization, control and documentation

Documentation and reproducibility are more and more important for quality assurance. The powerful VCD software represents an optimal solution for single multi furnace systems as well as charge documentation on the basis of Nabertherm controllers.

The VCD software is used to record process data of the series 500 and series 400 as well as various further Nabertherm controllers. Up to 400 different heat treatment programs can be stored. The controllers are started and stopped via the software at a PC. The process is documented and archived accordingly. The data display can be carried-out in a diagram or as data table. Even a transfer of process data to Excel™ for MS Windows™ (.csv format \*) or the generation of reports in PDF format is possible.



Example lay-out with 3 furnaces

### Features

- Available for controllers series 500 - B500/B510/C540/C550/P570/P580, series 400 - B400/B410/C440/C450/P470/P480, Eurotherm 3504 and various further Nabertherm controllers
- Suitable for operating systems Microsoft Windows 7/8/10/11
- Simple installation
- Setting, Archiving and print of programs and graphics
- Operation of controllers via PC
- Archiving of process curves from up to 16 furnaces (also multi-zone controlled)
- Redundant saving of archives on a server drive
- Higher security level due to binary data storage
- Free input of charge date with comfortable search function
- Possibility to evaluate data, files exportable to Excel™ for MS Windows™
- Generation of a PDF-report
- 24 languages selectable

### Extension Package 1 for display of an additional temperature measuring point, independent of the furnace controls

- Connection of an independent thermocouple, type S, N or K with temperature display on a supplied C6D display, e. g. for documentation of charge temperature
- Conversion and transmission of measured values to the VCD software
- For data evaluation, please see VCD-software features
- Display of measured temperature directly on the extension package

### Extension Package 2 for the connection of up to three, six or nine measuring point, independent of the furnace controls

- Connection of three thermocouples, type K, S, N or B to the included connecting box
- Possible extension of up to two or three connecting boxes with up to nine measuring points
- Conversion and transmission of measured values to the VCD software
- Data evaluation, see VCD features



VCD Software for Control, Visualisation and Documentation



Graphic display of main overview (version with 4 furnaces)

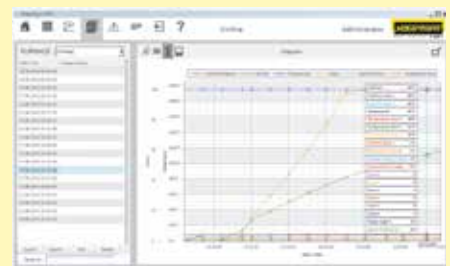

Graphic display of process curve

## PLC Controls HiProSystems



This professional process control with PLC controls for single and multi-zone furnaces is based on Siemens hardware and can be adapted and upgraded extensively. HiProSystems control is used when process-dependent functions, such as exhaust air flaps, cooling fans, automatic movements, etc., have to be handled during a cycle, when furnaces with more than one zone have to be controlled, when special documentation of each batch is required and when remote service is required. It is flexible and is easily tailored to your process or documentation needs.

### Alternative User Interfaces for HiProSystems

#### Process Control H500

This basic panel accommodates most basic needs and is very easy to use. Firing cycle data and the extra functions activated are clearly displayed in a table. Messages appear as text. Data can be stored on a USB stick using the „NTLog Comfort“ option.

#### Process Control H1700

Customized versions can be realized in addition to the scope of services of the H500. Display of basic data as online trend on a color 7" display with graphically structured interface.

#### Process Control H3700

Display of functions on a large 12" display. Display of basic data as online trend or as a graphical system overview. Scope as H1700.

### Remote Maintenance Router – Fast Support in Case of a Malfunction

For fast failure diagnosis in case of a malfunction, remote maintenance systems are used for HiProSystems-plants (depending on the model). The plants are equipped with a router, which will be connected to the internet by the customer. In case of a malfunction, Nabertherm is able to get access to the furnace controls via a secured connection (VPN tunnel) and to perform a malfunction diagnosis. In most cases, the problem can be directly solved by a technician on site according with supervision from Nabertherm.

If no Internet connection can be provided, we offer optionally the remote maintenance via LTE network as additional equipment.



H1700 with colored, tabular depiction



H3700 with colored graphic presentation



Router for remote maintenance

# Process Data Storage



The following options are available for industrial process documentation and the recording of data from several furnaces. These can be used to document the process data for the PLC controls.



NTLog Comfort for data recording of a Siemens PLC via USB stick

## Data Storing of HiProSystems with NTLog Comfort

The extension module NTLog Comfort offers the same functionality of NTLog Basic module. Process data from a HiProSystems control are read out and stored in real time on a USB stick. The extension module NTLog Comfort can also be connected using an Ethernet connection to a computer in the same local network so that data can be written directly onto this computer.

## Temperature Recorder

Besides the documentation via the software which is connected to the controls, Nabertherm offers different temperature recorders which can be used with respect to the application.

	Model 6100e	Model 6100a	Model 6180a
Data input using touch panel	x	x	x
Size of colour display in inch	5.5"	5.5"	12.1"
Number of thermocouple inputs	3	18	48
Data read-out via USB-stick	x	x	x
Input of charge data		x	x
Evaluation software included	x	x	x
Applicable for TUS-measurements acc. to AMS2750G			x

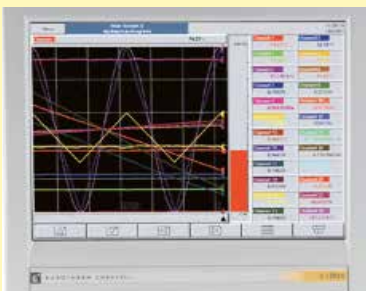

Temperature recorder

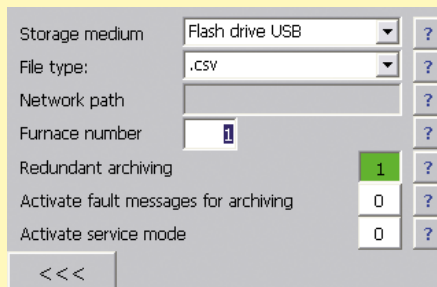

NTLog Comfort - Data recording via USB stick

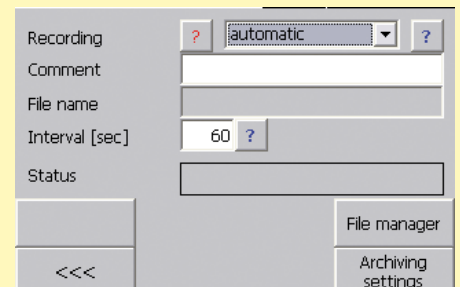

NTLog Comfort - Data recording online on the PC

## Nabertherm Control Center NCC

### PC-based control, process visualization and process documentation software

The Nabertherm Control Center as PC-supported furnace controls offers an ideal extension for furnaces with PLC based HiProSystem controls. The system has proven itself in many applications with increased demands on documentation and process reliability and also for convenient multi-furnace management. Many customers from the automotive, aviation, medical technology or technical ceramics sectors have been working successfully with this powerful software.



Retort furnace NR 300/08 for treatment in high vacuum

#### Standard Equipment

- Central furnace management
- Graphical furnace overview of up to 8 furnaces
- Tabular, clear program entry (100 program locations)
- Charge administration (article, quantity, additional information)
- Connection to the company network
- Adjustable access rights
- Online monitoring of the heat treatment
- Tamper-proof documentation
- Malfunction message list, adapted to the furnace model
- Archive function
- Scope of delivery includes PC and printer
- Measuring range calibration of up to 18 temperatures per measurement point. Multi-stage calibration is possible for applications with normative requirements.

#### Additional Equipment

- Reading in charge data via barcode
  - Simple data acquisition, ideal for frequently changing charges
  - Defined charge data ensures data quality
- Recipe storage with charge comparison
  - Comparison of charge and recipe to increase process reliability
- Adaptable access rights or access rights via employee cards
- Software extension to fulfill documentation requirements according to norms like AMS2750G (NADCAP), CQI9 or Food and Drug Administration (FDA), Part 11, EGV 1642/03
- Interface for connection to overriding systems
- SQL connection
- Redundant data storage
- Cellular connection or network connection for notification via SMS, e. g. in the event of malfunctions
- Control from different PC workstations
- Configuration as industrial PC or virtual machine
- PC cabinet
- UPS for PC
- Customization according to individual requirements



Retort furnace NR 80/11 with IDB safety concept for debinding under non-flammable protective gases



System overview



Furnace overview



Measurement range calibration



## Spare Parts and Customer Service — Our Service Makes the Difference

For many years the name **Nabertherm** has been standing for top quality and durability in furnace manufacturing. To secure this position for the future as well, Nabertherm offers not only a first-class spare parts service, but also excellent customer service for our customers. Benefit from more than 75 years of experience in furnace construction.

In addition to our highly qualified service technicians on site, our service specialists in Lilienthal are also available to answer your questions about your furnace. We take care of your service needs to keep your furnace always up and running. In addition to spare parts and repairs, maintenance and safety checks as well as temperature uniformity measurements are part of our service portfolio. Our range of services also includes the modernization of older furnace systems or new linings.

**The needs of our customers always have highest priority!**



- Very fast spare parts supply, many standard spare parts in stock
- Worldwide customer service on site with its own service points in the largest markets
- International service network with long-term partners
- Highly qualified customer service team for quick and reliable repair of your furnace
- Commissioning of complex furnace systems
- Customer training in function and operation of the system
- Temperature uniformity measurements, also according to standards like AMS2750G (NADCAP)
- Competent service team for fast help on the phone
- Safe teleservice for systems with PLC controls via a secured VPN line
- Preventive maintenance to ensure that your furnace is ready for use
- Modernization or relining of older furnace systems

### Contact us:

Spare parts

 [spares@nabertherm.de](mailto:spares@nabertherm.de)

 +49 (4298) 922-0

Customer service

 [service@nabertherm.de](mailto:service@nabertherm.de)

 +49 (4298) 922-333



**The whole World of Nabertherm: [www.nabertherm.com](http://www.nabertherm.com)**

Please visit our website [www.nabertherm.com](http://www.nabertherm.com) and find out all you want to know about us - and especially about our products.

In addition to current information and exhibition dates, there is of course the possibility of direct contact or an authorized dealer from our worldwide dealer network.

Professional Solutions for:

- Thermal Process Technology
- Additive Manufacturing
- Advanced Materials
- Fiber Optics/Glass
- Foundry
- Laboratory
- Dental
- Arts & Crafts

## Headquarters

**Nabertherm GmbH**  
Bahnhofstr. 20  
28865 Lilienthal, Germany  
Tel +49 4298 922 0  
contact@nabertherm.de

## Sales Organisation

**China**  
Nabertherm Ltd. (Shanghai)  
No. 158, Lane 150, Pingbei Road, Minhang District  
201109 Shanghai, China  
Tel +86 21 64902960  
contact@nabertherm-cn.com

**France**  
Nabertherm SARL  
20, Rue du Cap Vert  
21800 Quetigny, France  
Tel +33 6 08318554  
contact@nabertherm.fr

**Great Britain**  
Nabertherm Ltd., United Kingdom  
Tel +44 7508 015919  
contact@nabertherm.com

**Italy**  
Nabertherm Italia  
via Trento N° 17  
50139 Florence, Italy  
Tel +39 348 3820278  
contact@nabertherm.it

**Switzerland**  
Nabertherm Schweiz AG  
Altgraben 31 Nord  
4624 Härkingen, Switzerland  
Tel +41 62 209 6070  
contact@nabertherm.ch

**Benelux**  
Nabertherm Benelux, The Netherlands  
Tel +31 6 284 00080  
contact@nabertherm.com

**Spain**  
Nabertherm España  
c/Marti i Julià, 8 Bajos 7º  
08940 Cornellà de Llobregat, Spain  
Tel +34 93 4744716  
contact@nabertherm.es

**USA**  
Nabertherm Inc.  
64 Reads Way  
New Castle, DE 19720, USA  
Tel +1 302 322 3665  
contact@nabertherm.com



**All other Countries: Follow**  
<https://www.nabertherm.com/contacts>